

Operating instructions
Washer-disinfector for laboratory
glassware and laboratory utensils
PG 8583 CD



To avoid the risk of accidents or damage to the machine, it is **essential** to read these instructions before it is installed and used for the first time.

en - GB, AE, AU, IE, NZ, ZA



Notes about these instructions	7
Intended use	8
Spray pressure and spray arm monitoring	9
User profiles	10
Guide to the machine	11
Overview	11
Control panel	12
LEDs in the buttons	13
Warning and Safety instructions	14
Symbols on the machine	21
Using the machine	22
Display illustrations	22
Switching on	23
Switching off	23
Automatic switch-off (Auto-Off function)	23
Display interface	24
Menu operation	24
Settings in the menu	25
Symbols in the display	26
Commissioning	27
Installation and connection	27
Procedure	27
Opening and closing the door	31
Electronic door locking	31
Opening the door	31
Closing the door	31
Opening the door using the emergency release	32
Water softener	33
Water hardness	33
Setting the water hardness level	34
Filling the salt reservoir	36
Add salt reminder	38
Areas of application	39
Mobile units, baskets, modules and inserts	39
Adjusting the upper basket	40
Preparing the load	42
Chemical processes and technology	46
Adding and dispensing chemical agents	50
Using chemical agents	50
Dispensing systems	50
Labelling the siphons	50
Neutralising agent	51
Replenishing neutralising agent	51
Refill indicator	52
Dispensing neutralising agent	52

Contents

Cleaning agent.....	53
Replenishing liquid cleaning agent.....	53
Refill indicator.....	54
Dispensing liquid cleaning agent	54
Operation	55
Selecting a programme	55
Starting a programme.....	55
Starting a programme using delay start.....	55
Drying	56
Programme sequence indicator	58
At the end of the programme	58
Cancelling a programme	59
Programme cancelled due to a fault	59
Cancelling a programme manually.....	59
Settings ▾	60
Delay start.....	61
Drying	62
DOS venting	63
Filter change.....	64
Language ▾	64
Date	65
Time of day.....	67
Volume.....	70
Further settings	71
Code.....	73
Enter code	73
Log book.....	76
Report.....	77
Temperature unit.....	77
Programme settings	78
Air cooling.....	78
Release programme	79
Moving a programme: allocating programme selection buttons.....	80
Dispensing systems.....	81
DOS venting	82
Test programme.....	83
Interface.....	84
Water hardness.....	87
Display: Temperature.....	87
Display brightness and contrast.....	88
Switch off after (Auto-Off function).....	89
Factory default.....	90
Software version.....	90
Change name	91
Programme settings	92
Adjusting programme settings	92
Programme structure.....	92
Programme header.....	92
Programme blocks	93

Opening the menu	94
Reset programme	95
Altering a programme	96
Allocating wash blocks.....	97
Spray arm monitoring.....	98
Measuring conductivity	100
Change water quantity	104
Increasing drainage time	105
Setting the concentration level.....	106
Set wash blocktemperature	107
Drying unit	109
Process documentation	114
Retrospective output of cycle reports	117
External software.....	117
Report printer	117
Maintenance	118
Periodic checks	118
Routine checks.....	119
Cleaning the filters in the wash cabinet.....	119
Cleaning the spray arms.....	121
Cleaning the machine.....	123
Cleaning the control panel	123
Cleaning the door and the door seal.....	123
Cleaning the wash cabinet	123
Cleaning the door front	123
Preventing re-soiling.....	123
Checking mobile units, baskets, modules and inserts.....	124
Filter change	125
Changing the coarse filter	125
Changing the HEPA filter.....	126
Resetting the operating hours counter.....	127
Performance check.....	128
Problem solving guide	131
Technical faults and messages.....	131
Dispensing / dispensing systems	132
Insufficient salt / Water softener.....	134
Cancel with fault code	135
Process-related faults and messages	137
Door.....	139
Unsatisfactory cleaning and corrosion.....	140
Spray arm monitoring / conductivity / wash pressure.....	142
Water inlet and drainage.....	144
Noises.....	145
Printer / Serial interface	146
Remedial maintenance	147
Cleaning the drain pump and non-return valve	147
Clean the water intake filters	148

Contents

After sales service	149
Contacting Miele Service.....	149
Software version	150
Installation	151
Installation and levelling	151
Fitting the lid	152
Building under a continuous worktop.....	153
Electromagnetic compatibility (EMC)	154
Electrical connection	155
Equipotential bonding connection.....	155
Plumbing	156
Connection to the water supply	156
Connecting the drain hose	159
Programme chart	160
Free memory	160
Free memory	162
Universal	164
Standard	166
Intensive	168
Inorganic	170
Organica	172
Injector Plus	174
Pipettes.....	176
Plastics	178
Mini	180
Oil programme	182
Special 93°C-10'	184
Demin. rinse.....	186
Rinse.....	186
Drain	186
Technical data	187
Caring for the environment	188
Disposal of the packing material	188
Disposing of your old machine.....	188

Important warnings

 Information which is important for safety is highlighted in a thick framed box with a warning symbol. This alerts you to the potential danger of injury to people or damage to property. Read these warning notes carefully and observe the procedural instructions and codes of practice they describe.

Notes

Information of particular importance that must be observed is highlighted in a thick framed box.

Additional information and comments

Additional information and comments are contained in a simple frame.

Operating steps

Operating steps are indicated by a black square bullet point.

Example:

- Select an option using the arrow buttons and save your choice with *OK*.

Display

Certain functions are shown in display messages using the same font as that used for the function itself in the display.

Example:

Settings  menu.

Intended use

This Miele washer-disinfector can be used to reprocess laboratory glassware and laboratory utensils with water based media. The process includes cleaning, rinsing and where required disinfection and drying. Due to the wide variety of laboratory glassware and laboratory utensils on the market, it may be necessary in some cases to establish whether it is suitable for reprocessing in a washer-disinfector. This will depend on its use and the type of soiling present as well as disinfection parameters. Please also observe information provided by the manufacturer of the laboratory glassware and laboratory utensils.

Laboratory glassware and laboratory utensils suitable for reprocessing include a range of items from evaporating dishes to centrifuge tubes, for example:

- Vessels such as test tubes, beakers, flasks, cylinders, etc.
- Measuring vessels such as measuring cylinders, pipettes, volumetric flasks, etc.
- Dishes such as petri dishes, watch glasses, etc.
- Plates such as slides, sequencing plates, etc.
- Small items such as lids, spatulas, magnetic stirring rods, stoppers, etc.
- Other items such as funnels, pipe/hose pieces, etc.

Examples of application areas:

- Laboratories in schools, colleges and universities,
- Research, quality assurance, development, technology and production.
- Different areas of inorganic, organic, analytical and physical chemistry,
- Biology, microbiology and biotechnology,
- Hospital laboratories.

Laboratory glassware and laboratory utensils for reprocessing are referred to as the wash load if they are not more closely defined.

Processing conditions must be suitable for the wash load and for the type of soiling.

Chemical agents must be suitable for the type of soiling and for methods of analysis being used.

The use of a suitable carrier (mobile unit, basket, module, insert, etc.) is important to ensure the adequate cleaning of the load. Examples are given in the section "Areas of application".

This machine is programmed to carry out the final rinse with mains water or with processed water of a quality to suit the application (e.g. purified water, fully demineralised water or demineralised water). It is particularly important to ensure the appropriate water quality for the rinse and final rinse of items for analytical purposes.

The machine can be qualified for process validation.

The machine fulfills the requirements of Directive 2006/42/EC on machinery

IMPORTANT

Australia and New Zealand

This machine is not intended to be used to reprocess or disinfect medical devices or medical equipment.

Spray pressure and spray arm monitoring

The machine has a sensor for monitoring spray pressure in order, for example, to detect pressure fluctuations due to misloading or foam in the water circulation system. Spray pressure monitoring is set at the factory to active in the "Cleaning" and "Final rinse" wash blocks. The spray pressure monitoring result is documented together with process documentation.

Spray arm speed can also be monitored, e.g. for detection of blockages due to misloading or foam in the water circulation system. Spray arm speed monitoring can be activated or deactivated via the programmable settings.

Miele Service can make further settings for spray pressure and spray arm monitoring.

Intended use

User profiles

Daily operators

Daily operators must be instructed in operating and loading the machine and trained regularly to guarantee safe daily use. They require knowledge of machine reprocessing of laboratory glassware and utensils.

Tasks for daily routine operation are located in the Settings  menu. This menu is freely accessible to all users.

Administration

More advanced tasks, e.g. interrupting or cancelling a programme, require more detailed knowledge about the machine reprocessing of laboratory glassware and utensils.

Alterations or adaptations of the machine, e.g. accessories used or on-site conditions require additional specific knowledge of the machine.

Validation processes assume specialised knowledge of the machine reprocessing of laboratory glassware and utensils, of the processes involved and of applicable standards and legislation.

Administrative processes and settings are allocated to the Further settings. This is protected from unauthorised access by a code.

Overview

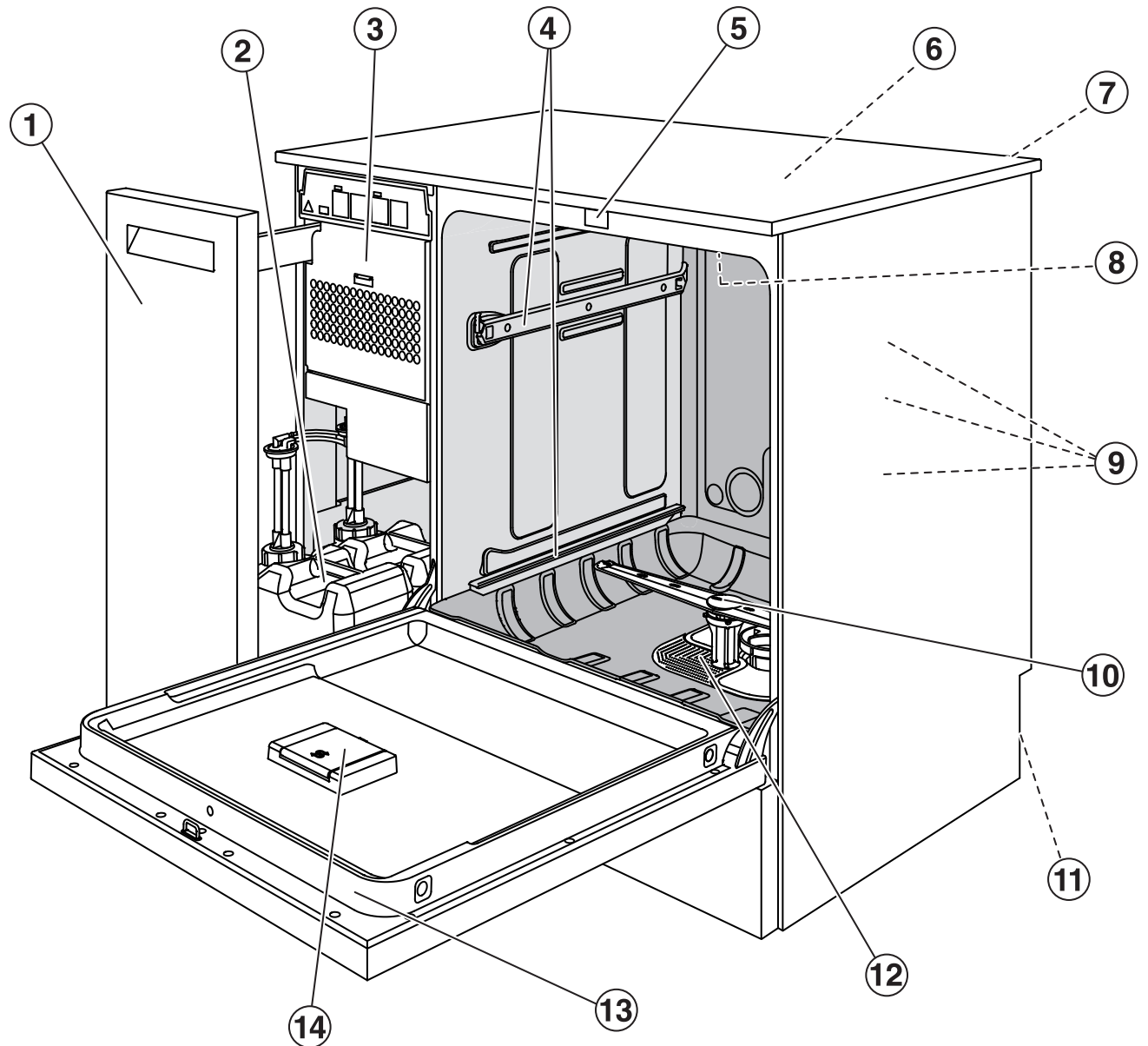

- ① Side unit
- ② Dispensing containers for chemical agents
- ③ Drying unit
- ④ Rails for baskets and mobile units
- ⑤ Comfort door locking mechanism
- ⑥ Test point for performance checks (Top, front right; only visible with lid removed)
- ⑦ Module slot for a communication module (Back, top right)
- ⑧ Upper machine spray arm
- ⑨ Plumbing connections for mobile units and baskets
- ⑩ Lower machine spray arm
- ⑪ On the back:
 - Second data plate
 - Electrical and plumbing connections
- ⑫ Filter combination
- ⑬ Data plate
- ⑭ Salt reservoir



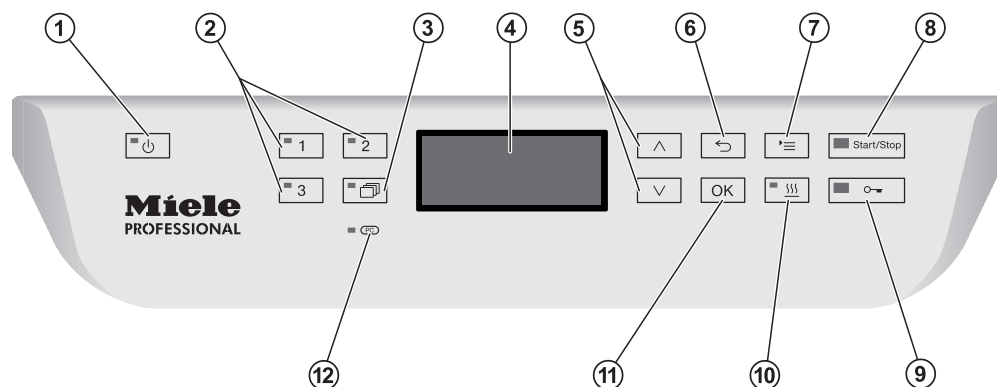

Control panel

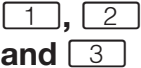

- ① **On/Off button**
For switching the washer-disinfector on and off.
- ② **1, 2 and 3 buttons**
Programme selection buttons.
Can be configured.
- ③ **Programme list button**
For accessing the list of all programmes.
- ④ **Display**
User interface and programme sequence display
- ⑤ **^ and v arrow buttons**
For navigating within the display
- ⑥ **↶ Cancel button**
For cancelling a process
(not for cancelling programmes)
- ⑦ **☰ Settings button**
For accessing the system settings menu.
- ⑧ **Start/Stop button**
For starting or cancelling a programme
- ⑨ **⏪ Door release button**
For opening the door before or after a programme
- ⑩ **☄ Drying button**
For switching drying on and off.
- ⑪ **OK button**
For selecting or confirming entries in the user interface.
- ⑫ **PC / Optical interface**
This is used by Miele service technicians to run diagnostic checks and can also be used to update programming data in the future.

LEDs in the buttons

The buttons on the control panel have LEDs (Light Emitting Diodes) that indicate the status of the washer-disinfector.

Button	LED	Status
 button	ON	The washer-disinfector is switched on.
	OFF	The washer-disinfector is switched off.
Programme selection buttons 	ON	The respective programme has been selected. At the end of the programme the LED will remain lit until a different programme is selected.
	OFF	The programme is not selected or the programme settings are being selected.
 button	ON	A programme has been selected from the programme list. At the end of the programme the LED will remain lit until a different programme is selected.
	OFF	No programme has been selected from the list or the programme settings are being selected.
 button	ON	The additional "Drying" function has been activated for the selected programme (not available for all programmes; see "Programme chart").
	OFF	The additional "Drying" function has been deactivated
Start/Stop button	ON	Programme running
	FLASHES GREEN	A programme has been selected but not yet started.
	FLASHES RED	A fault has occurred (see "Problem solving guide").
	OFF	A programme has finished.
 button	ON	The door is closed (locked) and there is no programme running.
	FLASHES	A programme has finished and the door is closed (locked).
	OFF	A programme is running or the door is open (unlocked).

Warning and Safety instructions

This machine complies with all statutory safety requirements. Inappropriate use can, however, lead to personal injury and material damage.

Read these instructions carefully before using it for the first time to avoid the risk of accidents and damage to the machine.

Keep these instructions in a safe place where they are accessible to users at all times.

Correct application

► This washer-disinfector is designed for use with the applications described in these operating instructions only. Alterations or conversions to the machine, or using it for purposes other than those for which it was designed, are not permitted and could be dangerous. This washer-disinfector must only be used for cleaning and disinfecting laboratory glassware and utensils if the manufacturer has stated that they are suitable for machine reprocessing.

Manufacturer's cleaning and maintenance instructions must also be observed.

Miele cannot be held liable for damage caused by improper or incorrect use or operation of the machine.

► This machine is intended for indoor use only.

Risk of injury

Please pay attention to the following notes to avoid injury

► This machine must be commissioned, serviced and repaired by a Miele authorised and trained service technician only. To ensure compliance with Good Laboratory Practice guidelines, Miele repair and maintenance contracts are recommended. Unauthorised repairs can pose considerable risks to the user.

► Do not install the machine in an area where there is any risk of explosion or of freezing conditions.

► In order to reduce the risk of water damage, the area around the machine should be limited to furniture and fittings that are designed for use in commercial environments.

► If the machine is built under, it must only be installed under a continuous worktop run which is firmly secured to adjacent units to improve stability.

► The electrical safety of this machine can only be guaranteed when correctly earthed. It is essential that this standard safety requirement is met. If in any doubt, please have the on-site wiring system tested by a qualified electrician. Miele cannot be held liable for the consequences of an inadequate earthing system (e.g. electric shock).

Warning and Safety instructions

- ▶ A damaged or leaking machine could be dangerous and compromise your safety. Disconnect the machine from the mains immediately and call the Miele Service Department.
- ▶ Personnel operating the machine should be trained regularly. Untrained personnel must not be allowed access to the machine or its controls
- ▶ Only use chemical agents which have been approved by their manufacturer for use in the application you are using. The chemical agent manufacturer is responsible for any negative influences on the material the load is made from and for any damage they may cause to the machine.
- ▶ Take care when handling chemical agents. These may contain irritant, corrosive or toxic ingredients.
Please observe the chemical agent manufacturer's safety instructions and safety data sheets.
Wear protective gloves and goggles.
- ▶ The machine is designed for operation with water and recommended additive chemical agents only. Organic solvents and flammable liquid agents must not be used in it.
This could cause an explosion, damage rubber or plastic components in the machine and cause liquids to leak out of it.
- ▶ The water in the cabinet must not be used as drinking water.
- ▶ Do not lift the machine by protruding parts such as the control panel or the opened service flap as these could be damaged or torn off.
- ▶ Do not sit or lean on the opened door. This could cause the machine to tip up and be damaged or cause an injury.
- ▶ Be careful when sorting items with sharp pointed ends and positioning them in the machine that you do not hurt yourself or create a danger for others.
- ▶ Broken glass can result in serious injury when loading or unloading. Broken glass items must not be processed in the machine.
- ▶ When using this machine in the higher temperature ranges, be especially careful not to scald or burn yourself or come into contact with irritant substances when opening the door. Where disinfecting agents are used there is a danger of inhaling toxic fumes.
- ▶ Should personnel accidentally come into contact with toxic vapours or chemical agents, follow the emergency instructions given in the manufacturer's safety data sheets.
- ▶ Mobile units, baskets, modules, inserts and the load must be allowed to cool down before they are unloaded. Any water remaining in containers could still be very hot. Empty them into the wash cabinet before taking them out.

Warning and Safety instructions

- ▶ Never clean the machine or near vicinity with a water hose or a pressure washer.
- ▶ The machine must be disconnected from the mains electricity supply before any maintenance or repair work is carried out.

Quality assurance

The following points should be observed to assist in maintaining quality standards when processing laboratory glassware and utensils to avoid damage to the loads being cleaned.

- ▶ If it is necessary to interrupt a programme in exceptional circumstances, this may only be done by authorised personnel.
- ▶ The standard of cleaning and disinfection must be routinely confirmed by the user. The process should be validated on a regular basis, and checked against documented control results.
- ▶ For thermal disinfection, use temperatures and temperature holding times to achieve the required infection prophylaxis in accordance with current health and safety regulations.
- ▶ Make sure items being washed are suitable for machine reprocessing and are in good condition. Plastic items must be thermally stable. Nickel plated items and aluminium items can be machine processed using special procedures only. Items containing iron, and soiling containing residual rust must not be placed in the cabinet.
- ▶ Chemical agents can, in certain circumstances, cause damage to the machine. Always follow the recommendations of the chemical agent manufacturer.
In case of damage or doubt about compatibility, please contact Miele.
- ▶ Abrasive substances must not be placed in the machine as they could cause damage to the mechanical components of the water supply. Any residues of abrasive substances on items to be washed must be removed without trace before reprocessing in the machine.
- ▶ Pre-treatments with cleaning or disinfecting agents can create foam, as can certain types of soiling and chemical agents. Foam can have an adverse effect on the cleaning and disinfection result.
- ▶ Processes must be set up such that foam cannot escape from the wash cabinet. It would hinder the correct functioning of the machine.
- ▶ The process used must be monitored on a regular basis by the supervisor to check foaming levels.
- ▶ To avoid the risk of damage to the machine and any accessories used with it caused by chemical agents, soiling and any reaction between the two please read the notes in "Chemical Processes and Technology".

Warning and Safety instructions

- ▶ Where a chemical agent is recommended on technical application grounds (e.g. a cleaning agent), this does not imply that the manufacturer of the machine accepts liability for the effect of the chemical on the items being cleaned.
Please be aware that changes in formulation, storage conditions etc. which may not be publicised by the chemical manufacturer, can have a negative effect on the cleaning result.
- ▶ When using a chemical agent it is essential that the manufacturer's instructions are followed. The chemical agent must only be used for the application it is designed for and in the situation specified, to avoid material damage and such dangers as a severe explosive chemical reaction (e.g. an explosive oxyhydrogen gas reaction).
- ▶ Always follow the relevant manufacturer's instructions on storage and disposal of chemical agents.
- ▶ In critical applications where very stringent requirements have to be met, it is strongly recommended that all the relevant factors for the process, such as chemical agents, water quality etc. are discussed with the Miele Application Technology specialists.
- ▶ If the cleaning result is subject to particularly stringent requirements, a regular quality control test should be carried out by the user to ensure that required standards of cleanliness are being achieved
- ▶ Mobile units, baskets, modules and inserts should only be used for the purpose they are designed for.
Hollow items must be thoroughly cleaned, internally and externally.
- ▶ Secure small and light items with cover nets or place in a mesh tray for small items, so that they do not block the spray arms.
- ▶ Empty any containers or utensils before loading them.
- ▶ The amount of residual solvents and acids on items going into the cabinet should be minimal.
There should be no more than a trace of any solvents with a flash point of below 21 °C.
- ▶ Chloride solutions, in particular hydrochloric acid, must not be placed in the cabinet.
- ▶ Ensure that solutions or steam containing chlorides or hydrochloric acid do not come into contact with the stainless steel outer casing of the machine in order to avoid any damage through corrosion.
- ▶ After any plumbing work the water pipework to the machine will need to be vented. If this is not done, components can be damaged.
- ▶ The gaps between a built-in machine and adjacent cabinetry must not be filled with silicone sealant as this could compromise the ventilation to the circulation pump.

Warning and Safety instructions

- ▶ Follow the installation instructions in the operating and installation instructions.

Warning and Safety instructions

Safety with children

- ▶ Children must be supervised in the vicinity of the machine. Do not allow children to play with the machine. They could get locked inside it.
- ▶ Children must not use the machine.
- ▶ Keep children away from chemical agents. These can cause burning in the mouth, nose and throat if swallowed, or inhibit breathing. Keep children away from the machine when the door is open. There could still be residual chemical agent in the cabinet. Observe the safety data sheets for the chemical agent and seek medical advice immediately if a child has swallowed chemical agent or got it in the eyes.

Using accessories

- ▶ Only Miele accessories should be connected to this machine. They must be suitable for the application they are required for. Consult Miele for details on the type of accessories that can be used.
- ▶ Only use Miele mobile units, baskets, modules and inserts with this washer-disinfector. Using mobile units, baskets, modules and inserts made by other manufacturers, or making modifications to Miele accessories can cause unsatisfactory cleaning results, for which Miele cannot be held liable. Any resultant damage would not be covered by the guarantee.

Symbols on the machine

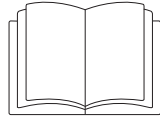

Warning:
Observe the operating instructions



Warning:
Danger of electric shock

Disposing of your old machine

► Please note that the machine may have contamination from blood, bodily fluids, pathogenic germs, facultative pathogenic germs, genetically modified material, etc. in it and must be decontaminated before disposal.

For environmental and safety reasons ensure the machine is completely drained of any residual water, chemical residues and cleaning agent. Observe safety regulations and wear safety goggles and gloves.

Make the door lock inoperable, so that children cannot accidentally shut themselves in. Then make appropriate arrangements for its safe disposal.

Miele cannot be held liable for damage caused by non-compliance with these Warning and Safety Instructions.

Using the machine

Control panel

The machine is operated exclusively by the buttons located on the stainless steel surfaces either side of the display. The display is not a touch screen.

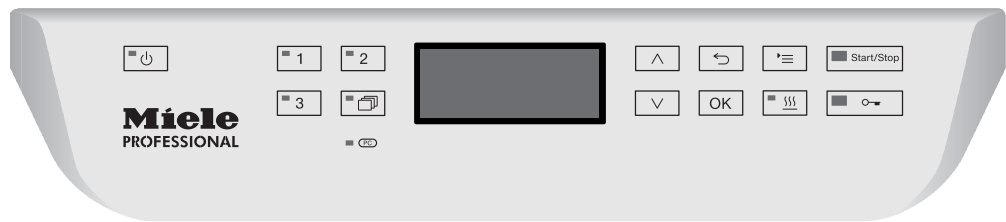



A light touch on the relevant button is sufficient to operate the functions. The buttons can also be pressed and held for approx. 20 seconds.

Display illustrations

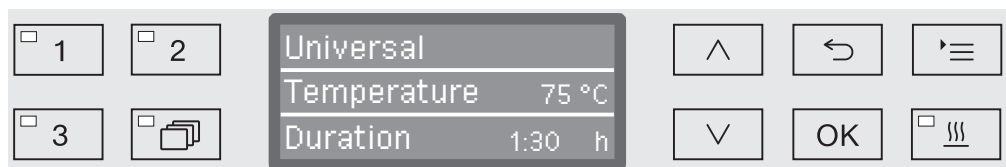
All display illustrations shown in these operating instructions are examples which can be different from the actual display screens shown.



The control buttons are shown next to the display. The ,  and *Start/Stop* buttons are not shown.

Switching on

The machine must be connected to the electrical supply.

- Press the  button until the LED lights up.

After that, the display will show the following:



As soon as the machine is ready for operation, the display changes to show the last selected programme, e.g.

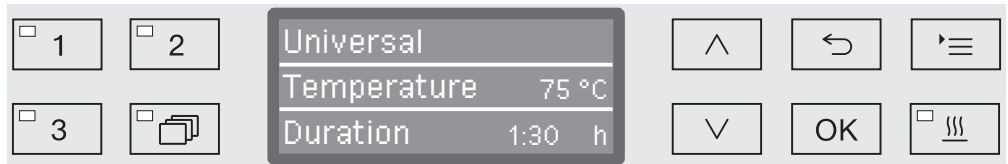

If the machine is being used for the first time, or if the factory settings have been reinstated, some basic parameters, e.g. language, date, time of day, etc. must first be set. To enable this, the display automatically changes to the relevant screen.

Switching off

- Press the  button.

The time of day can optionally be displayed when the machine is switched off (see "Settings  / Time of day").

Automatic switch-off (Auto-Off function)

To save energy the machine has an automatic switch-off function (Auto-Off function). If the machine is not used for a pre-determined duration, it switches itself off automatically. Automatic switch-off can be optionally activated and deactivated (see "Further settings / Switch off after").

- Switch the machine on again using the  button.

Using the machine

Display interface

The machine is controlled by menus. The menus are displayed in a 3-line display on the control panel.

The name of the menu (top line) and up to two options are shown. The currently selected option is highlighted, e.g.



Menu operation

'≡

Settings button

For accessing the system settings menus.

^ and v

Arrow buttons

The arrow buttons are used to navigate up and down by row within a menu. Press and hold the button to automatically scroll through the list to the end of the menu. Press the button again to continue navigating.

Parameter values can also be altered in defined increments using the arrow buttons. Instructions for this can be found in the relevant sections.

OK

OK button

The *OK* button is used for confirming (acknowledging) a selection or for saving input. The display then moves to the next menu or, when entering parameter values, to the next input position. Instructions for this can be found in the relevant sections.

↶

Cancel button

Before the *OK* button has been pressed, a process can be cancelled at any time by pressing the ↶ button. The menu is then ended early and the display changes to the next menu level up. Any setting changes made will not be saved.

Settings in the menu

All menu descriptions in these operating instructions are structured as follows

Input procedure The input procedure describes the complete sequence required to reach a particular menu level. The menu options shown must be selected individually using the arrow buttons and then confirmed with *OK*.

Example: '≡ button
▶ Settings |
▶ Time of day
▶ Clock display

If a menu level is already displayed, the path does not need to be input completely. If, for example, the Settings | menu is already displayed, you do not need to press the '≡ button again. In this case simply follow the sequence from Settings | onwards.

Display view When selecting a menu, the last menu used is generally opened.

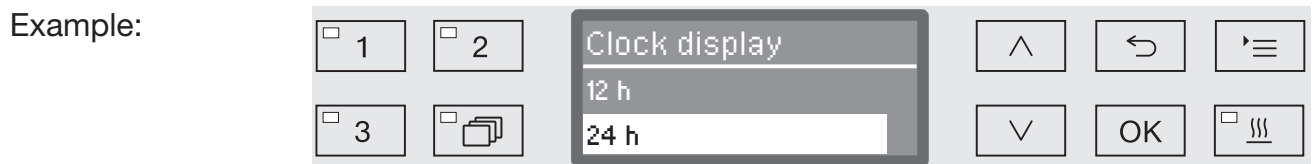

Options All available menu options are listed together with a short description.

Example:

- 12 h
Time of day display in 12 hour format (am/pm).
- 24 h
Time of day in 24 hour format.

Method Then further instructions are given.

Example:

- Select an option using the ^ and v arrow buttons.
- Press *OK* to save the setting.

Using the machine

Symbols in the display



Navigation arrows

If a menu consists of more than two options, two navigation arrows are shown at the side of the menu options.



Use the \wedge and \vee arrow buttons on the control panel to navigate through the menu.



Dotted line

If a menu contains more than two options, the end of the option list is marked by a dotted line. The last entry appears above the line, the first entry below it.



Tick

If there are several options available, the current setting is marked with a tick \checkmark .

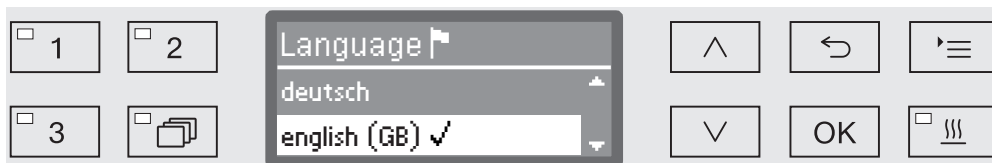

System messages

The **i** symbol denotes system messages. These give information, such as if the level is too low in the supply containers or a reminder for the next service.



System messages are displayed at the start and end of a programme and have to be confirmed (acknowledged) individually with **OK** or all together at the end of the programme by opening the door. If the **i** symbol appears in the display during a programme, the system messages can be accessed by pressing and holding the **OK** button.



Fault messages

In the event of a fault a warning triangle is shown in place of the **i** symbol. See "Problem solving guide" and "After sales service" for more information.

Installation and connection

Before commissioning the machine must be securely installed, and the water inlet and drain hoses and the mains cable correctly connected. See "Installation", "Plumbing connections" and "Electrical connection" and the installation diagram supplied.

Procedure

During commissioning a set procedure is followed which must not be interrupted. The display will automatically guide you through the process.

All settings, except for selecting plumbing connections, can be retrospectively altered via the Settings  and Further settings menus.

The settings made during the commissioning process are only adopted after a complete programme has been run. If the programme is interrupted or if no programme is started and the machine is switched off, the commissioning process must be carried out again.

Switching on

- Press the  button until the LED lights up.

Select language

The commissioning process starts with selecting the language.



- Use the \wedge and \vee arrow buttons to select the language you want and touch *OK* to save.

Select temperature unit

The menu for selecting the temperature unit will then appear.

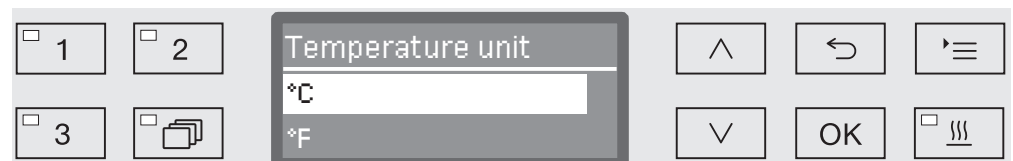

- Use the \wedge and \vee arrow buttons to select the temperature unit you want and touch *OK* to save.

Commissioning

Select the date format

The menu for selecting the date format will then appear.



– DD = Day

– MM = Month, and

– YY = Year.

- Use the \wedge and \vee arrow buttons to select the date format you want and touch *OK* to save.

Set the date

The menu for setting the date will then appear.

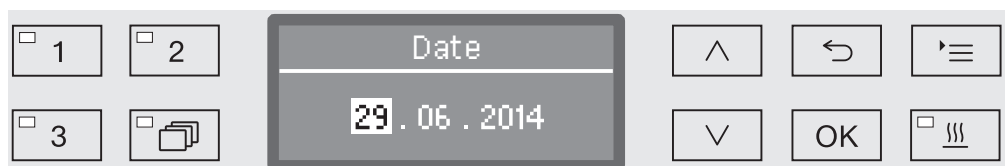

- Use the \wedge and \vee arrow buttons to set the day, month and year and touch *OK* to save each one.

Select Clock display

The menu for selecting the clock format will then appear.



- Use the \wedge and \vee arrow buttons to select the format you want and touch *OK* to save.

Set the time of day

The menu for setting the display for the time of day will then appear.

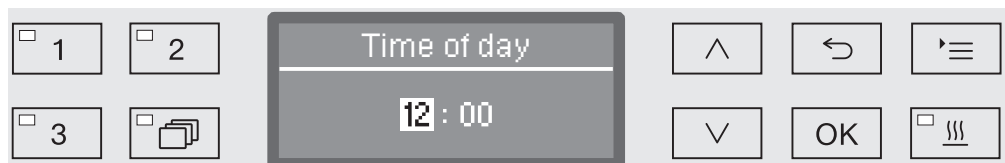

- Use the \wedge and \vee arrow buttons to select the hours and minutes and touch *OK* to save each one.

Setting the water hardness level

The menu for setting the water hardness will then appear.

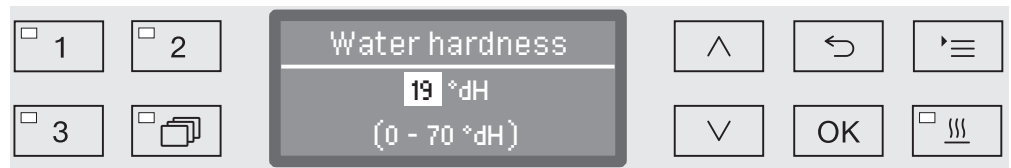

The bottom line of the display shows the possible input range. Water hardness input values can be found in the chart in "Water softener/ Settings chart".

Your local water authority can give you information about the exact water hardness in your area.

Where the water hardness fluctuates, e.g. between 1.4 - 3.1 mmol/l (8 - 17 °dH), always programme the machine to the higher value, 3.1 mmol/l (17 °dH) in this example.

- Set the water hardness using the arrow buttons \wedge (higher) and \vee (lower) and touch *OK* to save.
- Write down the water hardness in "Water softener / Water hardness".

Select plumbing connections

The menu for setting plumbing connections will then appear.

Unused plumbing connections, e.g. if there is only one connection, can be deactivated here.

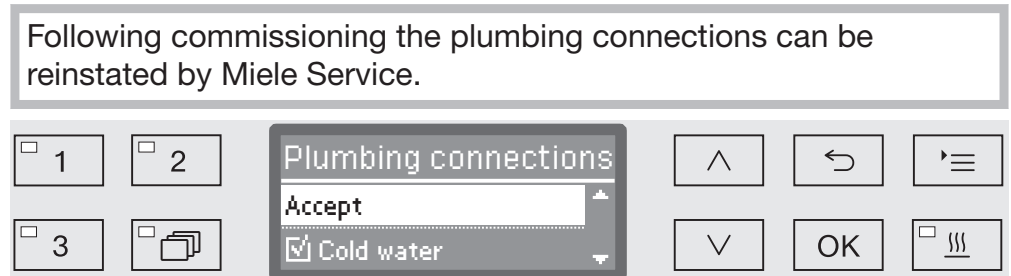

The plumbing connection is set via multiple choice. A box is shown in the display next to all plumbing connections. If the connection is activated, a tick can be seen in it. Select to activate or deactivate the plumbing connections.

- Use the \wedge and \vee arrow buttons to select the plumbing connection you want. Plumbing connections are activated or deactivated by touching *OK*.
- To save the selection select the *Accept* option at the end of the list and confirm with *OK*.

Commissioning

Commissioning completed

Commissioning is completed when the following message is displayed.



- Confirm the message with *OK*.

The machine is now ready for use.

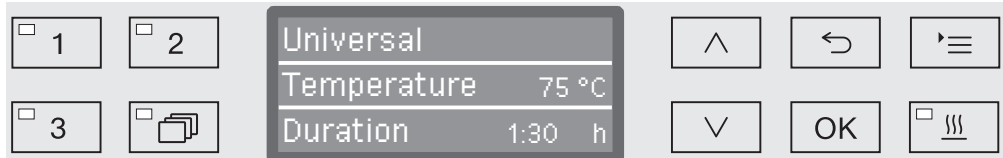

After commissioning every programme starts with reactivation of the water softener.

Electronic door locking

The washer-disinfector is equipped with a Comfort door lock. When the door is closed, the Comfort door lock automatically pulls the door into the correct position, electronically locking the door.

Opening the door

An electronically locked door can only be opened if:

- the washer-disinfector is connected to the electrical supply and is switched on (the LED for the ⏻ button is lit up),
 - there is no programme running,
 - the temperature in the wash cabinet is less than 70 °C and
 - the ◯➔ LED is lit up.
- Press the ◯➔ button to open the door.

The Comfort door lock opens the door slightly. The LED goes out as soon as the door is unlocked.

The control panel of the washer-disinfector is also a door handle.

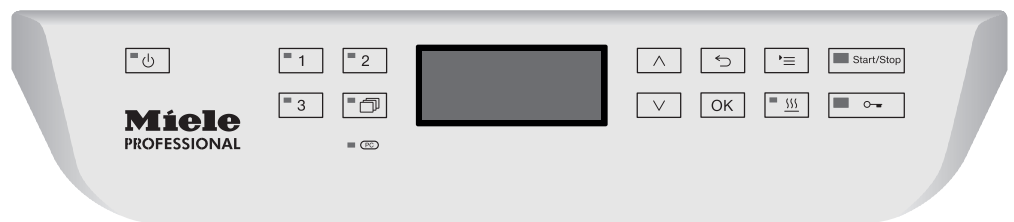

- Grasp the handle underneath the control panel and lower the door to open it.

Closing the door

- Ensure that there are no objects or items in the load obstructing the door.

⚠ Do not put your hand inside the door as it is closing.
Danger of injury.

- Lift the door until it engages with the door lock. The door is automatically pulled into the correct position by the Comfort door lock.

Opening and closing the door

Opening the door using the emergency release

The emergency release may only be used when it is no longer possible to open the door normally, e.g. in the event of a power cut.

⚠ If the emergency release is operated during a programme cycle, hot water and cleaning agents can escape.
Risk of scalding, burning and chemical burns.

- Push against the door so that less force is needed to operate the emergency release.

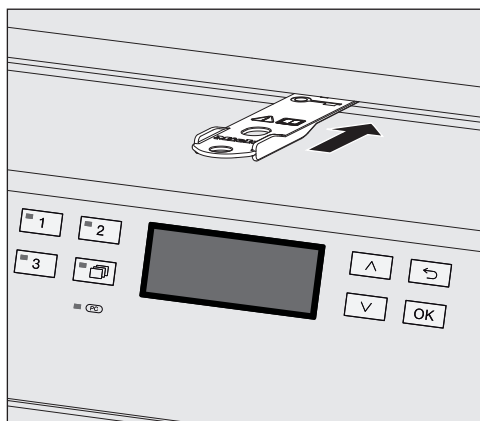

- Push the tool supplied in the accessory pack horizontally into the gap between the door and the lid or worktop. The right hand edge of the tool must align with the outer right hand edge of the display.
- Press against the unlocking mechanism with the tool until you hear the door unlock. The door can now be opened.

If the washer-disinfector is switched on, activation of the emergency release will be recorded in the process documentation and the following message will appear in the display:



The message remains in the display until the door is closed. It is not recorded if the machine is switched off.

Water hardness

In order to achieve good cleaning results, the machine needs to operate with soft water. Hard water results in the build-up of calcium deposits on the load and in the machine.

Mains water with a hardness of more than 0.7 mmol/l (4 °dH German scale) must be softened. This occurs automatically in the built-in water softener.

The water softener must be set to the exact hardness of the mains water (see "Water softener / Setting the water hardness").

Your local water authority will be able to tell you the exact degree of hardness in the mains water supply. For future servicing it is useful to make a note of your water hardness level. Enter your water hardness level here:

_____ ° dH or mmol/l

The water softener must also be reactivated at regular intervals. To do this special reactivation salt is required (see "Water softener / Filling the salt reservoir"). Reactivation occurs automatically during a programme sequence.

If the hardness level of your water is constantly less than 0.7 mmol/l (= 4 °dH) salt is not required for the water softener. The water hardness level must however still be set.

Water softener

Setting the water hardness level

Water hardness can be set between 0 and 12.6 mmol/l (0 - 70 °dH).

- Open the menu as follows:

☰ button

▶ Further settings

▶ Water hardness

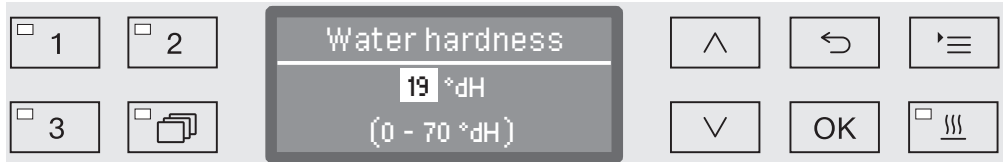

The bottom line of the display shows the possible input range. Water hardness input values can be found in the chart on the next page.

Where the water hardness fluctuates, e.g. between 1.4 - 3.1 mmol/l (8 - 17 °dH), always programme the machine to the higher value, 3.1 mmol/l (17 °dH) in this example.

- Set the water hardness level using the arrow buttons (∧ = higher and ∨ = lower).
- Press "OK" to save the setting.

Settings

°dH	°f	mmol/l	Display
0	0	0	0
1	2	0.2	1
2	4	0.4	2
3	5	0.5	3
4	7	0.7	4
5	9	0.9	5
6	11	1.1	6
7	13	1.3	7
8	14	1.4	8
9	16	1.6	9
10	18	1.8	10
11	20	2.0	11
12	22	2.2	12
13	23	2.3	13
14	25	2.5	14
15	27	2.7	15
16	29	2.9	16
17	31	3.1	17
18	32	3.2	18
19	34	3.4	19 *)
20	36	3.6	20
21	38	3.8	21
22	40	4.0	22
23	41	4.1	23
24	43	4.3	24
25	45	4.5	25
26	47	4.7	26
27	49	4.9	27
28	50	5.0	28
29	52	5.2	29
30	54	5.4	30
31	56	5.6	31
32	58	5.8	32
33	59	5.9	33
34	61	6.1	34
35	63	6.3	35

°dH	°f	mmol/l	Display
36	65	6.5	36
37	67	6.7	37
38	68	6.8	38
39	70	7.0	39
40	72	7.2	40
41	74	7.4	41
42	76	7.6	42
43	77	7.7	43
44	79	7.9	44
45	81	8.1	45
46	83	8.3	46
47	85	8.5	47
48	86	8.6	48
49	88	8.8	49
50	90	9.0	50
51	92	9.2	51
52	94	9.4	52
53	95	9.5	53
54	97	9.7	54
55	99	9.9	55
56	101	10.1	56
57	103	10.3	57
58	104	10.4	58
59	106	10.6	59
60	108	10.8	60
61	110	11.0	61
62	112	11.2	62
63	113	11.3	63
64	115	11.5	64
65	117	11.7	65
66	119	11.9	66
67	121	12.1	67
68	122	12.2	68
69	124	12.4	69
70	126	12.6	70

*) Factory default setting

Filling the salt reservoir

Use only special, coarse-grained reactivation salt with a granule size of approx. 1 - 4 mm.

Do not under any circumstances use other types of salt such as table salt, agricultural or gritting salt. These may contain insoluble additives which can impair the functioning of the water softener.

⚠ Inadvertently filling the salt reservoir with cleaning agent will cause serious damage to the water softener.

Before filling the salt container make sure that you have picked up the right packet of reactivation salt.

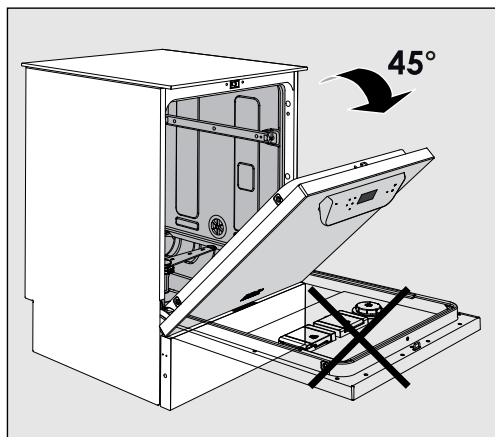

- Open the door to an angle of approx. 45°. This ensures that the salt flows into the reservoir more easily.

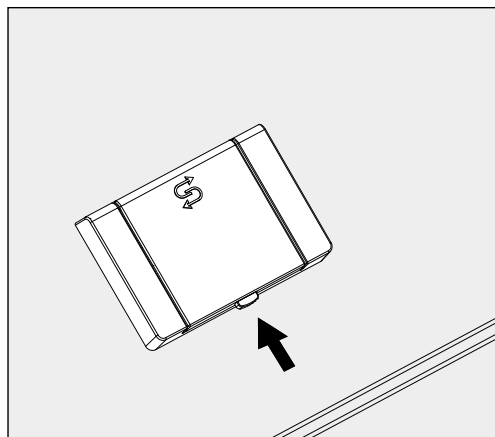

- Press the yellow button on the salt reservoir with the  symbol on it in the direction of the arrow. The flap will spring open.
- Lift up the funnel.

The reservoir takes approx. 1.4 - 2 kg of salt, depending on the type of salt and how much is left in.

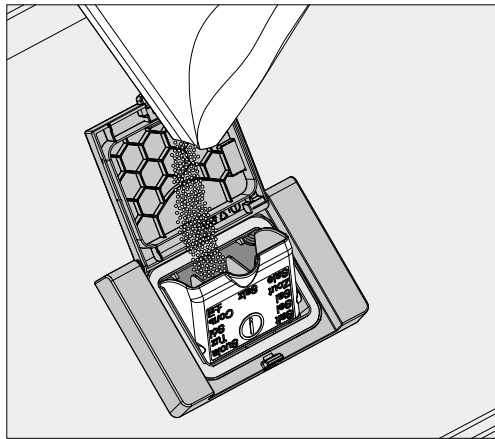

⚠ Do not fill the reservoir with water.
The reservoir could overflow when filled with salt.

- Add salt only until the funnel of the salt reservoir is full, so that it can close properly. Do not add more than 2 kg of salt.

As the salt reservoir is being filled, displaced water (saline solution) may run out.

- Clean any excess salt from the area around the salt reservoir and especially from the seal. **Do not** use running water as this can cause the salt reservoir to overflow.
- Close the funnel.
- Run the Rinsing programme after refilling salt.

This will ensure that any traces of salt and saline solution are dissolved and rinsed away.

Salt and saline solution which has overflowed can cause corrosion damage if they are not rinsed away.

Water softener

Add salt reminder

If the salt level in the reservoir is low, the following reminder will appear:



- Confirm the message with the *OK* button and
- fill the reservoir as described.

When the message first appears, there may be sufficient salt for a further programme, depending on the water hardness level set.

If there is no saline solution left in the water softener, a relevant message will appear in the display and the machine will be locked for further use.

The machine can be used again a few seconds after the salt has been refilled.

Mobile units, baskets, modules and inserts

This machine can be equipped with an upper and lower basket or a mobile unit which can be fitted with different inserts and modules or exchanged for special accessories depending on the items to be washed.

Select accessories which are appropriate for the application.

Information on the individual areas of application can be found on the following pages, as well as in the operating instructions for the mobile units, baskets, modules and inserts (if available).

For all areas of application defined in "Intended use" Miele offers suitable accessories such as mobile units, baskets, modules and inserts and special fittings. Contact Miele for more information.

Water supply

Mobile units and baskets with spray arms or other rinse fittings are equipped with one or more connection points to the water supply. When loading baskets, mobile units, etc into the machine, connect these to the water connection points in the back panel of the wash cabinet. The mobile units and baskets are held in place by the wash cabinet door when closed.

Any free connections in the back panel are closed mechanically.

Older models of mobile units and baskets

Only use older models of mobile units and baskets in this machine in consultation with Miele. In particular mobile units and baskets with water supply pipes for spray arms and injector manifolds must be converted to the new type of water connector.

Conversion must be carried out by Miele Service and is only available for selected models.

 The fitting of connectors for the water supply of mobile units and baskets must be carried out by Miele Service. Fitting faults on mobile units and baskets can cause damage to the machine.

Following conversion, mobile units and baskets can no longer be used in older models of the machine.

Areas of application

Adjusting the upper basket

Height-adjustable upper baskets can be adjusted between three positions with 2 cm between each position to accommodate items of different heights.

To adjust the height, the brackets with rollers on the side of the upper basket and the water connector at the back of the basket have to be moved. The roller brackets are each secured to the upper basket by two screws. The water connector consists of the following components:

- A stainless steel plate with 2 apertures,
- a plastic connection piece and
- 6 screws.

Only adjust the upper basket horizontally. The baskets are not designed to be positioned on a slant (one side up, one side down). Altering the height will alter loading heights for both the upper and lower baskets.

To adjust the upper basket:

- Remove the upper basket by pulling it out until a resistance is felt and lifting it off the runners.
- Unscrew the roller brackets and the water connector.

To adjust the upper basket to the ...

... Upper position:

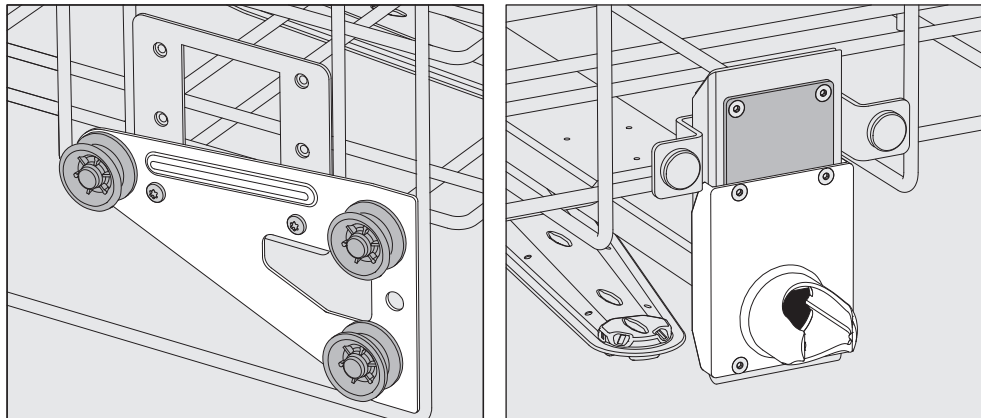

- Move the roller brackets on both sides to the lower position and secure them firmly.
- Position the stainless steel plate over the openings in the water supply pipe so that the upper aperture is covered. Secure the stainless steel plate at the top with 2 screws. Place the water connector in the lower aperture of the stainless steel plate so that the middle aperture is covered. Secure the water connector with 4 screws.

... Middle position:

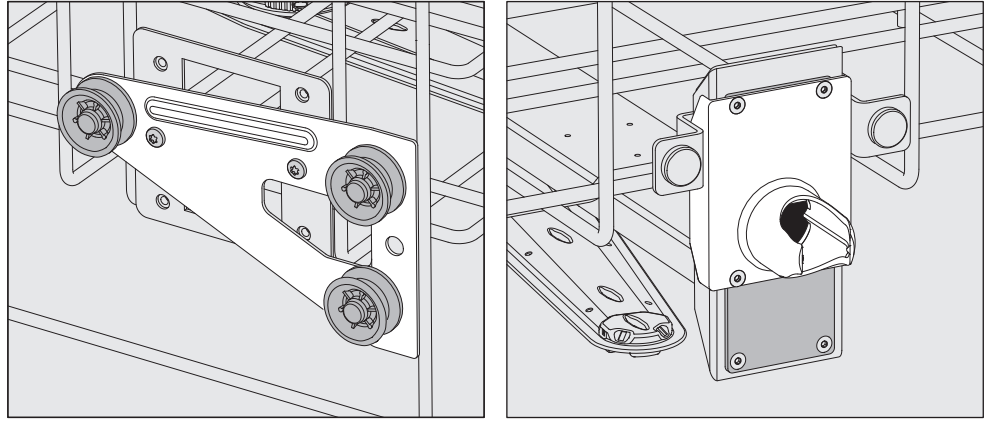

- Move the roller brackets on both sides to the middle position and secure them firmly.
- Position the stainless steel plate over the openings in the water supply pipe so that one of the outer apertures is covered. Secure the stainless steel plate at the top or bottom with 2 screws. Place the water connector in the middle aperture of the stainless steel plate so that the outer aperture is covered. Secure the water connector with 4 screws.

... Lower position:

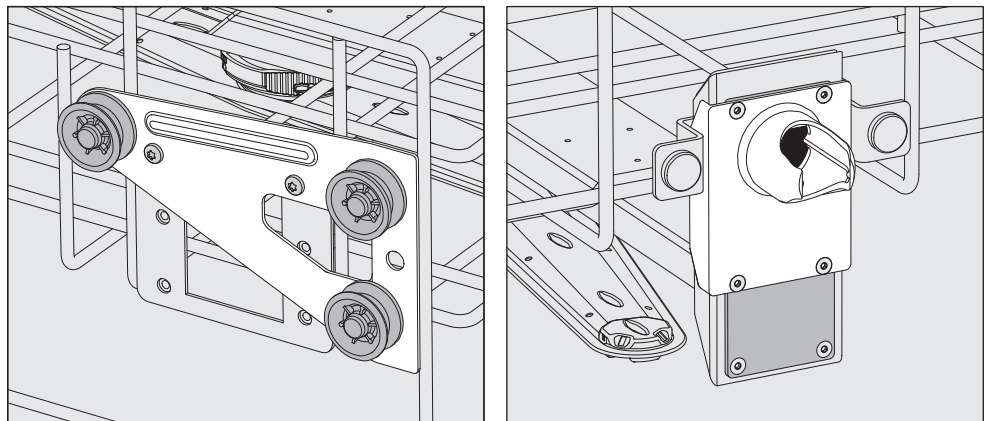

- Move the roller brackets on both sides to the top position and secure them firmly.
- Position the stainless steel plate over the openings in the water supply pipe so that the lower aperture is covered. Secure the stainless steel plate at the bottom with 2 screws. Place the water connector in the upper aperture of the stainless steel plate so that the middle aperture is covered. Secure the water connector with 4 screws.

Then check:

- Replace the upper basket on the rails and push it in carefully to check that the water connector is positioned correctly.

Preparing the load

⚠ Only items which have been declared by their manufacturer as suitable for machine reprocessing may be processed. The manufacturer's specific reprocessing instructions must be observed.

Special injector nozzles, irrigation sleeves or adapters may be required for appropriate internal cleaning, depending on the load. These, together with other accessories, are available from Miele.

- Arrange the load so that water can access all surfaces. This ensures that it gets properly cleaned.
- Do not place items to be cleaned inside other pieces where they may be concealed.
- Hollow items must be thoroughly cleaned, internally and externally.
- Ensure that items with long narrow hollow sections can be flushed through properly before placing them in a fitting or when connecting them to a water connection.
- Hollow vessels should be inverted and placed in the correct mobile units, baskets, modules and inserts to ensure that water can flow in and out of them unrestricted.
- Deep-sided items should be placed at an angle to make sure water runs off them freely.
- Tall, narrow, hollow items should be placed in the centre of the baskets or units if possible to ensure better water coverage.
- Take apart any items which can be dismantled according to the manufacturer's instructions and process the individual parts separately from each other.
- Lightweight items should be secured with a cover net (e.g. an A 6) and small items placed in a mesh tray to prevent them blocking the spray arms.
- The spray arms must not be blocked by items which are too tall or which hang down in their path.
- Broken glass can result in serious injury when loading or unloading. Broken glass items must not be processed in the machine.
- Nickel and chrome plated items and items made of aluminium require special procedures and are not generally suitable for machine reprocessing.
- With items which are made entirely or partly of plastic, observe the maximum thermal stability for the items and select an appropriate programme or adjust the temperature of the programme.

Observe the further information given in the following sections as necessary depending on area of application.

Preparing the load

- Empty all containers before loading into the machine (paying particular attention to relevant regulations).
- Remove non-water soluble residues such as paint, adhesives and polymer compounds using appropriate solvents.
- Rinse wash load items which have been in contact with chloride solutions or hydrochloric acid thoroughly with water before loading in the machine and drain well.

⚠ The amount of residual solvents and acids on items going into the cabinet should be minimal.

There should be no more than a trace of any solvents with a flash point of below 21 °C.

⚠ Chloride solutions, in particular hydrochloric acid, must not be placed in the cabinet.

- Scoop nutrient media (Agar) out of petri dishes.
- Shake out any blood residues and remove any clots.
- If necessary rinse the wash load briefly with water to prevent coarse soiling entering the machine.
- Remove stoppers, corks, labels, sealing residues, etc.
- Secure small items, such as stoppers and taps in suitable baskets for small items.

It may be necessary in individual cases to check whether extremely stubborn contamination e.g. vacuum grease, paper labels, etc. which could affect the cleaning result, must be removed in advance.

It must be determined whether wash load items which are contaminated with microbiological material, pathogenic germs, facultative pathogenic bacteria, genetically modified material etc. need to be sterilised prior to machine reprocessing.

Areas of application

Carry out a visual check before starting every programme:

- Is everything correctly loaded/connected for cleaning?
- Was the recommended loading template followed?
- Can the lumen / narrow sections of hollow items be accessed by the wash fluid?
- Are the spray arms clean and do they rotate freely?
- Are the filters clean?
Remove any coarse soiling and clean them if necessary.
- Are the removable modules, injector nozzles, irrigation sleeves and other rinsing fittings securely connected?
- Are the baskets and modules or mobile units correctly connected to the water supply and are the water connectors undamaged?
- Are all chemical containers sufficiently filled?

The following must be checked at the end of every programme:

- Carry out a visual check of the load for cleanliness.
- Check that all hollow items are still securely located on their injector nozzles.

 Any hollow items that have become disconnected from their fittings during reprocessing must be reprocessed.

- Check that the lumen of hollow items are free of obstruction.
- Check that injector nozzles and connectors are securely held in position in the baskets or inserts.

Wash load...

...wide necked

Wash load items with wide necks, e.g. beakers, wide necked Erlenmeyer flasks and petri dishes, or cylindrical items, e.g. test tubes, can be cleaned inside and out by rotating spray arms. To do this the wash load is positioned in full, half or quarter inserts and placed in an empty lower basket or an upper basket with a spray arm.

...narrow necked

Baskets with special injector modules are available for wash load items with narrow necks, e.g. narrow necked Erlenmeyer flasks, round bottomed flasks, measuring flasks and pipettes.

The injector units and modules come with their own operating instructions.

When loading please note:

- Place petri dishes in the appropriate insert with the dirty side facing towards the middle.
- Place pipettes with the pointed end facing downwards.
- Quarter segment inserts should be positioned at a minimum 3 cm distance from the edge of the upper or lower basket.
- Position quarter segment inserts for test tubes around the middle to leave the corners of the upper or lower basket free.
- Use a cover net to avoid breakages if required.

Chemical processes and technology

In this section you will find a description of the causes of common chemical reactions which can occur between different types of soiling, chemical agents and the components of the machine, along with their remedies as necessary.

This section is intended as a guide. If unforeseen interactions occur during reprocessing, or if you have any queries on this subject, please seek advice from Miele.

General notes	
Problem	How to resolve it
<p>If elastomers (hoses and seals) and plastics in the machine are damaged, this can lead to, for example, swelling, shrinking, hardening or brittleness of materials leading to the development of tears and cracks. Components can then not function correctly and this generally leads to leaks.</p>	<p>– Establish the cause of the damage and rectify it.</p> <p>See information regarding "Chemical agents", "Soiling" and "Reaction between chemical agents and soiling".</p>
<p>Heavy foaming during a programme affects cleaning and rinsing results. Foam escaping from the wash cabinet can cause damage to the machine. Cleaning processes cannot be regulated and validated where there has been a build-up of foam.</p>	<p>– Establish the cause of the foam and rectify it.</p> <p>– Check the process used regularly to monitor foaming levels.</p> <p>See information regarding "Chemical agents", "Soiling" and "Reaction between chemical agents and soiling".</p>
<p>Corrosion to stainless steel in the wash cabinet and to accessories can give them a different appearance:</p> <ul style="list-style-type: none"> – rust (red marks / discolouration), – black marks / discolouration, – white marks / discolouration (etched surface). <p>Corrosive pitting can lead to the machine not being water-tight. Depending on application corrosion can influence cleaning and rinsing results (laboratory analysis) or cause corrosion to stainless steel items in the cabinet.</p>	<p>– Establish the cause of the corrosion and rectify it.</p> <p>See information regarding "Chemical agents", "Soiling" and "Reaction between chemical agents and soiling".</p>

Chemical processes and technology

Chemical agents	
Problem	How to resolve it
<p>The ingredients in chemical agents have a strong influence on the longevity and functionality (throughput) of the dispensing system.</p>	<ul style="list-style-type: none"> – Follow the chemical agent manufacturer's instructions and recommendations. – Carry out a regular visual check of the dispensing system (siphons, hoses, dispensing containers etc.) for any damage. – Regularly check the flow rate of the dispensing system. – Ensure that the regular cycle of maintenance is observed. – Please contact Miele Service for advice.
<p>Chemical agents can damage elastomers and plastics in the machine and accessories.</p>	<ul style="list-style-type: none"> – Follow the chemical agent manufacturer's instructions and recommendations. – Carry out a regular visual check of any accessible elastomers and plastics for damage.
<p>Hydrogen peroxide can release large amounts of oxygen.</p>	<ul style="list-style-type: none"> – Use only validated processes. – The wash temperature must be lower than 70 °C when using hydrogen peroxide. – Please contact Miele Service for advice.
<p>The following chemical agents can cause large amounts of foam to build up:</p> <ul style="list-style-type: none"> – Cleaning agents and rinsing agents containing tensides. <p>Foam can occur:</p> <ul style="list-style-type: none"> – in the programme block in which the chemical agent is dispensed, – in the following programme block if it has been spilt, – in the following programme with rinsing agent if it has been spilt. 	<ul style="list-style-type: none"> – Process parameters in the wash programme, such as dispensing temperature, dosage concentration etc. must be set to ensure the whole process is foam free or very low foaming. – Please observe chemical agent manufacturer's instructions

Chemical processes and technology

Chemical agents	
Problem	How to resolve it
<p>De-foaming agents, especially silicone based ones can cause the following:</p> <ul style="list-style-type: none"> – deposits to build up in the cabinet, – deposits to build up on the load, – damage to elastomers and plastics in the machine, – damage to certain plastics (e.g. polycarbonate and plexiglass) in the load being processed. 	<ul style="list-style-type: none"> – De-foaming agents should be used in exceptional cases only, for instance when absolutely essential for the process. – The wash cabinet and accessories should be periodically cleaned without a load and without de-foaming agent using the Organic programme. – Please contact Miele Service for advice.
Soiling	
Problem	How to resolve it
<p>The following substances can damage elastomers (hoses and seals) and plastics in the washer-disinfector:</p> <ul style="list-style-type: none"> – oil, wax, aromatic and unsaturated hydrocarbons, – emollients, – cosmetics, hygiene and care products such as creams (analytical applications). 	<ul style="list-style-type: none"> – Refit the washer-disinfector with oil resistant elastomers. – Depending on usage wipe the lower door seal on the washer-disinfector periodically with a lint-free cloth or sponge. Clean the wash cabinet and accessories without a load using the Inorganic programme. – Process the load using the Oil programme programme (where this is available) or use a special programme that dispenses emulsifiers.
<p>The following substances can lead to a heavy build-up of foam during washing and rinsing:</p> <ul style="list-style-type: none"> – some disinfecting agents and dishwashing detergents, – reagents for analysis e.g. for microtiter plates, – cosmetics, hygiene and care products such as shampoos and creams (analytical applications), – active foaming agents such as tensides. 	<ul style="list-style-type: none"> – Thoroughly rinse items in water beforehand. – Select a cleaning programme with at least one short pre-rinse in cold or hot water. – Depending on application use de-foaming agents that do not contain silicone oils.

Chemical processes and technology

Soiling	
Problem	How to resolve it
<p>The following substances cause corrosion to stainless steel in the wash cabinet on accessories:</p> <ul style="list-style-type: none"> – hydrochloric acid, – other substances containing chlorides such as sodium chloride etc., – concentrated sulphuric acid, – chromic acid, – particles of iron and swarf. 	<ul style="list-style-type: none"> – Thoroughly rinse items in water beforehand. – Put the drip-dry items to be washed into the mobile units, baskets, modules and inserts and start a programme as soon as possible after placing in the washer-disinfector.
Reaction between chemical agents and soiling	
Problem	How to resolve it
<p>Natural oils and fats can be emulsified with alkaline chemical agents. This can lead to a heavy build-up of foam.</p>	<ul style="list-style-type: none"> – Use the Oil programme. – This special programme dispenses emulsifiers (pH neutral) in the pre-rinse. – Depending on application use de-foaming agents that do not contain silicone oils.
<p>Soiling containing high protein levels such as blood can cause a heavy build-up of foam when processed with alkaline chemical agents.</p>	<ul style="list-style-type: none"> – Select a cleaning programme with at least one short pre-rinse in cold water.
<p>Non-precious metals such as aluminium, magnesium and zinc can release hydrogen when processed with very acidic or alkaline chemical agents (oxyhydrogen reaction).</p>	<ul style="list-style-type: none"> – Please observe chemical agent manufacturer's instructions

Adding and dispensing chemical agents

Using chemical agents

⚠ Only use chemical agents designed specifically for use in machine and follow the manufacturer's instructions on their application.
Please observe carefully any instructions relating to non-toxic residues.

⚠ Caution when using chemical agents. Some agents may be corrosive and irritant.
The relevant safety regulations and the chemical agent manufacturer's safety data sheets must be observed.
Wear protective goggles and gloves.

Contact Miele for information about suitable chemical agents.

Highly viscous (thick) chemical agents can affect the dispenser monitoring and lead to inaccurate data. In this instance please contact Miele Service for advice.
The viscosity does not affect dosage concentration levels.

Dispensing systems

The machine is equipped with a number of internal dispensing systems for chemical agents:

- Neutralisation agent
This is dispensed using a siphon.
- Liquid detergent
This is dispensed via a siphon.

An additional internal dispensing system can be fitted retrospectively by Miele Service if required.

Labelling the siphons

Liquid chemical agents from external containers are dispensed by siphons. Colour coding the siphons can be helpful for correct dispensing.

Miele use and recommend the following:

- Blue: for cleaning agent
- Red: for neutralising agent
- Green: for chemical disinfection agents or an additional second cleaning agent
- White: for acidic chemical agent
- Yellow: for free choice

Neutralising agent

Neutralising agent (pH setting: acidic) neutralises any residues of alkaline cleaning agents on the surface of the load.

Neutralising agent is dispensed automatically in the Interim rinse phase after the main wash (see Programme charts). The reservoir must be filled and the dispensing system vented for this to occur.

In the Inorganic programme neutralising agent is dispensed additionally for an acidic pre-wash.

Replenishing neutralising agent

- Open the drawer in the side unit.
- Remove the neutralising agent container (red marking) and place it on the open cabinet door or on a surface which is robust and easy to clean.
- Unscrew and remove the siphon. Place the siphon on the open cabinet door.
- Replace the empty container with a full one.

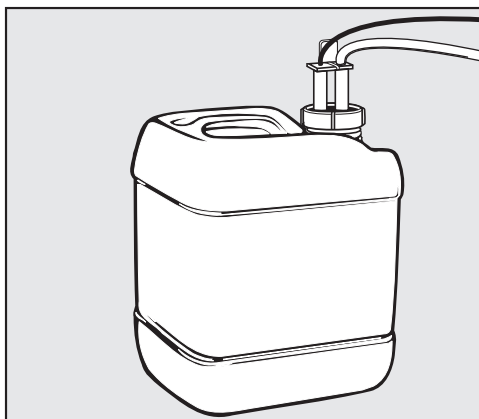

- Push the siphon into the opening of the container and screw it back on tightly. Observe the colour coding.
- Wipe up any spilled process chemical thoroughly.
- Place the container back in the drawer in the side cabinet.
- Close the drawer. Ensure that the dispensing tubes and cables are not kinked or trapped.
- Vent the dispensing system as necessary (see "Settings  / Venting DOS").

Checking consumption

Check consumption regularly by checking the fill levels in the supply containers and replace containers in good time to avoid the dispensing system being sucked completely dry.

Adding and dispensing chemical agents

Refill indicator

When the fill level is low in the DOS 3 supply container for neutralising agent you are reminded to refill it.



- Confirm the message shown with *OK* and
- Refill the neutralising agent as described.

If it has run out, the machine will be locked for further use.
It will be ready for use again when the supply container has been replaced.

Dispensing

neutralising agent

For adjusting dispensing concentration see "Further settings / Dispensing systems".

Cleaning agent

⚠ Use only cleaning agent which is suitable for washer-disinfectors.
Do not use cleaning agents for domestic dishwashers.

The washer-disinfecter is designed exclusively for use with liquid cleaning agent. The liquid cleaning agent is dispensed from an external supply container via a siphon.

For environmental reasons it is important to always consider the following factors when selecting a cleaning agent:

- How alkaline does the cleaning agent need to be for the cleaning application involved?
- Are protein-removing enzymes required and is the programme sequence suitable for this?
- Are tensides required for proper dispersal and emulsification?
- Is a cleaning agent containing active chlorine required or can an active chlorine-free cleaning agent be used?

For cleaning specific types of soiling, and for information on the optimum cleaning agents and additives to use for liquid dispensing, please contact the Miele Professional Department.

Replenishing liquid cleaning agent

- Open the drawer in the side unit.
- Remove the liquid cleaning agent container (blue marking) and place it on the open cabinet door or on a surface which is robust and easy to clean.
- Unscrew and remove the siphon. Place the siphon on the open cabinet door.
- Replace the empty container with a full one.

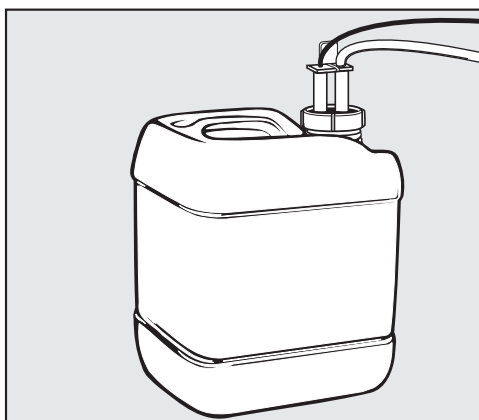

- Push the siphon into the opening of the container and screw it back on tightly. Observe the colour coding.
- Wipe up any spilled process chemical thoroughly.
- Place the container back in the drawer in the side cabinet.

Adding and dispensing chemical agents

- Close the drawer. Ensure that the dispensing tubes and cables are not kinked or trapped.
- Vent the dispensing system as necessary (see "Settings  / Venting DOS").

Checking consumption

Check consumption regularly by checking the fill levels in the supply containers and replace containers in good time to avoid the dispensing system being sucked completely dry.

Refill indicator

When the fill level is low in the DOS 1 supply container for liquid cleaning agent you are reminded to replenish it.

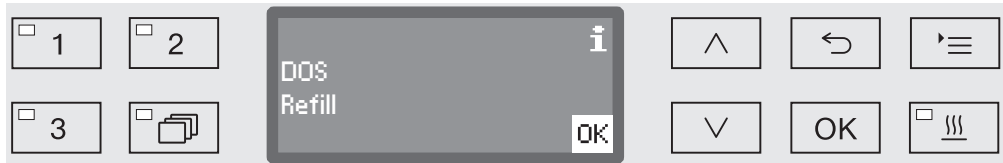

- Confirm the message shown with *OK* and
- replenish the liquid cleaning agent as described.

If the liquid cleaning agent has run out, the machine will be locked for further use.
It will be ready for use again when the supply container has been replaced.

Dispensing liquid cleaning agent

For adjusting dispensing concentration see "Further settings / Dispensing systems".

Selecting a programme ...

... using the short-cut buttons
... from the programme list

- Select a programme using short-cut buttons 1, 2 or 3.
- Press the  button and
- use the ^ and v arrow buttons to highlight a programme and confirm your selection with OK.

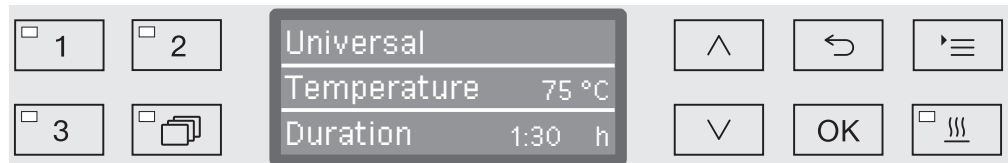



The LED in the button selected will light up and the relevant programme will appear in the display. The LED in the *Start/Stop* button also starts to flash.

Another programme can be selected at any time before a programme has started. Once it has started, programme selection is locked.

Always select the programme depending on the type of load and degree and type of soiling, or on infection prevention issues. The programmes and their areas of application are described in the Programme overview at the end of these operating instructions.

Starting a programme

- Close the door.
When the door is closed, the LED in the  button will light up.
- Press the *Start/Stop* button.
The LED in the *Start/Stop* button will light up constantly and the LED in the  button will go out.

Starting a programme using delay start

The start of a programme can be delayed, for example to benefit from economy rates of electricity or to clean the cabinet before it is used the next day. A delay start time between 1 minute and 24 hours can be selected in one minute increments (see "Settings  / Time of day").

Delay start must be switched on in the Settings menu (see "Settings  / Delay start").

If soiling is left to dry on the load for too long, the processing result can be adversely affected and there is also a risk of corrosion for stainless steel items.

Operation

Setting the start time

- Select a programme.
- Press the **OK** button before starting the programme.



- Use the arrow buttons \wedge (higher) and \vee (lower) to set the hours and confirm your selection with the **OK** button.

When the **OK** button is pressed, the display jumps automatically to the next input position. You cannot go back to the previous entry. If a mistake is made, the process must be cancelled using the \leftarrow button and repeated.

- Set the minutes using the arrow buttons \wedge (higher) and \vee (lower) and save your entry with **OK**.

The start time is now saved and can be changed as described at any time up to activation of delay start.

Activating delay start

- Delay start is activated with the *Start/Stop* button.

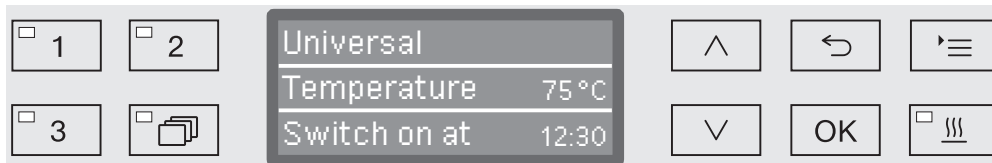

The selected programme with the start time set is shown in the display. If the automatic switch off after function is activated (see "Further settings / Switch off after"), the machine switches itself off after the set time until the programme start time set is reached.

Deactivating delay start

- Press the \leftarrow button or switch the machine off using the \odot button.

Drying

The additional "Drying" function accelerates the drying process at the end of the programme.

When the drying function is activated and the door is closed, the drying unit feeds heated and HEPA-filtered air into the wash cabinet for active drying of the load. The heated air is conducted via the steam condenser and can be cooled down if necessary (see "Further settings / Air cooling").

The drying function can be pre-selected for all programmes with a drying phase or can be retrospectively switched on or off every time a programme is selected (see "Settings \blacksquare / Drying").

The drying function is switched on or off by pressing the \equiv button before starting the programme. The LED in the button will indicate whether the additional function is switched on or off. The programme drying duration can also be altered.

When the drying function is activated, the programme duration will be longer. However the drying duration is not calculated in the programme time left shown in the display. It will be displayed during the drying phase only.

Activating and deactivating drying

- Select a programme.
- Press the  button before the programme start.

If the drying duration (Drying time) is set as changeable (Time changeable?) in the programme settings, the time set can be altered. Otherwise the drying duration set is not changeable and can only be confirmed by touching OK.

If drying is deactivated

If the drying function has been previously deactivated, it can be activated by pressing a button.



The pre-set drying duration for this programme is shown in minutes (min) in the display. If the duration can be changed, the possible setting range is displayed in the bottom line (left-hand diagram). Otherwise the pre-set drying duration range will be shown (right-hand diagram).

- Alter the drying duration using the arrow buttons \wedge (higher) and \vee (lower) and save the setting with *OK* to activate drying.

If drying is activated

If the drying function has been activated, you can choose either to deactivate the drying function or to reset the drying duration as described above.



– Deactivate

Drying is deactivated.

– Set the time

You can alter the drying duration with this option.

- Select an option using the arrow buttons \wedge and \vee and confirm this with *OK*.

Programme sequence indicator

After the programme has started the programme sequence can be followed in the three-line display



Top line – Programme name, e.g. Universal.

Middle line The following parameters can be checked using the arrow buttons \wedge and \vee :

- Current programme block, e.g. Main wash 1,
- Actual or required temperature (depending on the display set, see "Further settings / Display: Temperature").
- Cycle number
- Conductivity (only with conductivity meter)

Bottom line – Time left (in hours; under an hour, in minutes)

At the end of the programme

A programme is usually finished when the following parameters and messages are shown in the display:

Top line – Programme name.

Middle line Continuously alternating between:

- (Parameter met/not met)
- Cycle number
- Conductivity in final wash block (only with conductivity meter)

Bottom line – Programme finished

The LED in the *Start/Stop* button also goes out and the LED in the \odot button begins to flash. In the factory default state an acoustic tone also sounds for approx. 10 seconds (see "Settings \blacksquare / Volume").

labelling="Section-Header">Cancelling a programme

⚠ If a programme is cancelled, the items in the washer-disinfector must be reprocessed again.

⚠ Be careful when opening the door.
The wash load could be hot. Danger of scalding, burning and chemical burns.

Programme cancelled due to a fault

The programme stops and an error message appears in the display. Take appropriate steps to resolve the fault, depending on its cause (see "Problem solving guide").

Cancelling a programme manually

A programme which is already running should only be cancelled if strictly necessary, e.g. if the wash load is moving about significantly.

- Press and hold the *Start/Stop* button until the display changes to the following view:



- Select *Yes* using the \wedge and \vee arrow buttons.
- The programme is cancelled when the *OK* button is pressed. Entry of a code may also be required (see "Further settings / Code")

If no button is pressed for several seconds, or if the process is cancelled using the \curvearrowright button, the display will revert to the programme sequence display.

Restarting the programme

- Start the programme again or select a new programme.

The structure of the Settings  menu is shown below. The menu incorporates all relevant functions to support daily routine tasks.

In the structure overview all options which can be permanently selected have boxes beside them. Factory settings are indicated by a tick . You will find an explanation of how to change settings after the overview.

Settings

- ▶ Delay start
 - ▶ No
 - ▶ Yes
- ▶ Drying
 - ▶ No
 - ▶ Yes
- ▶ DOS venting
 - ▶ DOS_
- ▶ Change the filter
 - ▶ Coarse filter / HEPA filter
 - ↔ Reset counter
 - ▶ Yes
 - ▶ No
- ▶ Language 
 - ▶ deutsch
 - ▶ english (GB)
 - ▶ ...
- ▶ Date
 - ▶ Date format
 - ▶ DD:MM:YY
 - ▶ MM:DD:YY
 - ▶ Set
- ▶ Time of day
 - ▶ Set
 - ▶ Display
 - ▶ On
 - ▶ On for 60 seconds
 - ▶ Do not display
 - ▶ Clock display
 - ▶ 12 h
 - ▶ 24 h
- ▶ Volume
 - ▶ Keypad tone
 - ▶ Buzzer tones
 - ▶ Programme end
 - ▶ Warning

Delay start

This setting must be activated for delay start to be available for use.

- Open the menu as follows:

☰ button

▶ Settings 

▶ Delay start



– No

Delay start is deactivated.

– Yes

Delay start is activated and can be used for all programmes.

- Select an option using the ^ and v arrow buttons.
- Press *OK* to save the setting.

Drying

The drying function can be preset or deactivated for all programmes with a drying phase (see Programme charts).

The additional "Drying" function accelerates the drying process at the end of the programme.

When the drying function is activated and the door is closed, the drying unit feeds heated and HEPA-filtered air into the wash cabinet for active drying of the load. The heated air is conducted via the steam condenser and can be cooled down if necessary (see "Further settings / Air cooling").

- Open the menu as follows:

☰ button

▶ Settings 

▶ Drying



– No

The drying function is automatically deactivated for all programmes.

– Yes

The drying function is activated for all programmes. The programme duration is lengthened if the drying function is activated.

- Select an option using the ^ and v arrow buttons.
- Press *OK* to save the setting.

DOS venting

The dispensing system for liquid chemical agents can only dispense reliably if the system has been purged of air.

The DOS system must only be vented:

- if the dispensing system is being used for the first time,
- if the liquid cleaning agent container was not refilled or replaced in time and the DOS system was sucked dry.

Before venting, ensure that the liquid chemical agent container is sufficiently full and the siphons are securely screwed to the containers. Only one DOS system can be vented at a time.

■ Open the menu as follows:

'≡ button

▶ Settings 

▶ DOS venting

▶ DOS... (name of dispensing system)

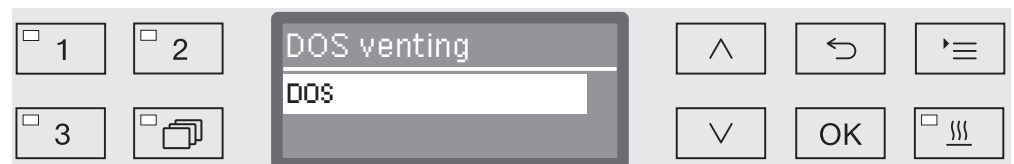

Automatic venting will start when the dispensing system is selected. Once started, the automatic venting process can no longer be cancelled.

- Select a dispensing system using the ^ and v arrow buttons.
- Press OK to start the venting process.

Automatic venting is successfully completed when the following message appears in the display:

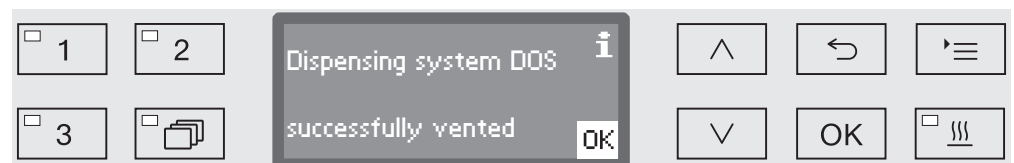

Filter change

The air filter in the drying unit must be replaced regularly with a new one.

For more information on changing the filter see "Maintenance / Changing the filter".

Language



The language set will be used in the display.

- Open the menu as follows:

'≡ button

▶ Settings 

▶ Language 

The flag symbol  after the Settings  and Language  menu options acts as a guide if a language which you do not understand has already been set.



A list will appear in the display with all the languages available. The currently selected language has a tick ✓ beside it.

The factory default language is set as english (GB).

- Use the ^ and v arrow buttons to select the language you want.
- Press OK to save the setting.

The display will change immediately to the language selected.

Date

The date is required e.g. for process documentation. The date format and the current date have to be set.

Select the date format

The selected date format appears in the display and in the process documentation.

- Open the menu as follows:

☰ button

▶ Settings 

▶ Date

▶ Date format



– DD = Day

– MM = Month

– YY = Year.

- Use the ^ and v arrow buttons to select the date format you want.
- Press OK to save the setting.

Set the date

The current date will be set in the selected date format.

- Open the menu as follows:

☰ button

▶ Settings 

▶ Date

▶ Set

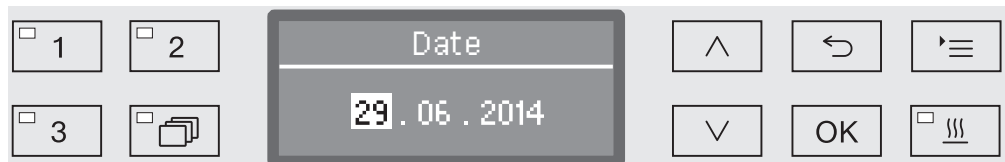

- Use the arrow buttons \wedge (higher) and \vee (lower) and confirm your entry using the *OK* button.

When the *OK* button is pressed, the display jumps automatically to the next input position. You cannot go back to the previous entry. If a mistake is made, the process must be cancelled using the \curvearrowright button and repeated.

- Use the arrow buttons \wedge (higher) and \vee (lower) to set the month/day and confirm your entry using the *OK* button.
- Use the arrow buttons \wedge (higher) and \vee (lower) to set the year and press the *OK* button to save the date.

The date will be saved when the *OK* button is pressed for the last time.

Time of day

The time of day is required for process documentation, delay start, the machine log book and the display. The date format and the current time of day have to be set.

There is no automatic adjustment between summer and winter time (daylight savings).
You need to make this adjustment yourself as necessary.

Selecting the time of day format

To set the format for the time of day in the display:

- Open the menu as follows:

☰ button

- ▶ Settings 
- ▶ Time of day
- ▶ Clock display



– 12 h

Time of day in 12 hour format (am/pm).

– 24 h

Time of day in 24 hour format.

- Use the \wedge and \vee arrow buttons to select the date format you want.
- Press *OK* to save the setting.

Set the time of day

To set the format for the time of day:

- Open the menu as follows:

☰ button

▶ Settings 

▶ Time of day

▶ Set

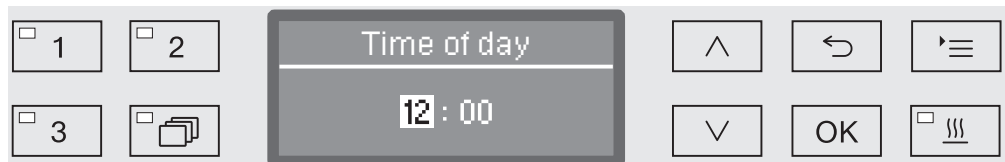

- Use the arrow buttons \wedge (higher) \vee (lower) to set the hours and confirm your entry with the *OK* button.

When the *OK* button is pressed, the display jumps automatically to the next input position. You cannot go back to the previous entry. If a mistake is made, the process must be cancelled using the \curvearrowright button and repeated.

- Use the arrow buttons \wedge (higher) and \vee (lower) to set the minutes and press the *OK* button to save the time of day.

The time of day will be saved when the *OK* button is pressed for the last time.

Display

The time of day can, if required, be displayed when the machine is switched off.

- Open the menu as follows:

☰ button

- ▶ Settings 
- ▶ Time of day
- ▶ Display

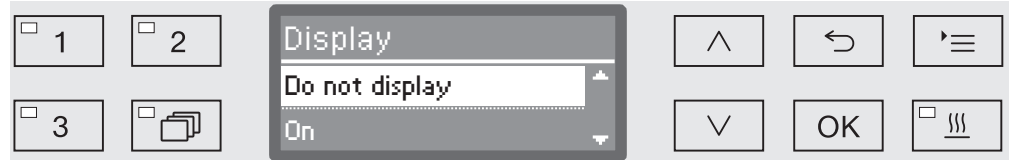

– On

Time of day is constantly displayed when the machine is switched off.

– On for 60 seconds

Time of day is displayed for 60 seconds when the machine is switched off.

– Do not display

The display is switched off.

- Select an option using the \wedge and \vee arrow buttons.
- Press *OK* to save the setting.

Volume

A buzzer which is integrated into the control panel can give an acoustic signal in the following situations:

- When buttons are pressed (keypad tone)
- At the end of the programme
- System messages (information)

■ Open the menu as follows:

☰ button

▶ Settings 

▶ Volume

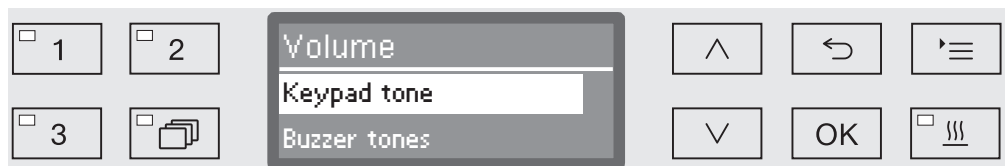

– Buzzer tones

Setting the buzzer volume for programme end and system messages (information)

– Keypad tone

Setting the buzzer volume for keypad tone.

■ Select an option using the \wedge and \vee arrow buttons.

■ Confirm your selection with *OK*.

When Keypad tone has been selected you can adjust the volume immediately. When Buzzer tones has been selected you must first select which tone, Warning or Programme end, you would like to adjust the volume for.

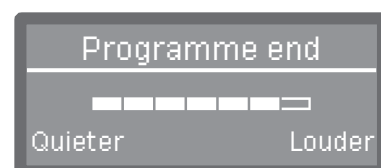
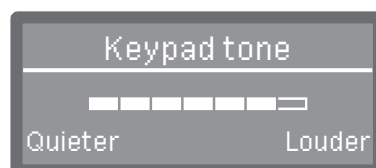

The volume level is represented by a bar chart. On the lowest setting the buzzer tone is switched off.

■ Use the arrow buttons \wedge (Louder) and \vee (Quieter) to set the volume.

■ Press *OK* to save the setting.

The Further settings menu incorporates all administrative processes and settings.

The Further settings menu can only be accessed by using a code. If you do not have the code, contact a user with appropriate access rights or cancel the process using the ↵ button.

In the structure overview all options which can be permanently selected have boxes beside them. Factory settings are indicated by a tick . You will find an explanation of how to change settings after the overview.

Further settings

- ▶ Code
 - ▶ Cancel programme
 - ▶ Code not required
 - ▶ Code required
 - ▶ Change code
- ▶ Log book
 - ▶ Consumption: Water
 - ▶ Consumpt.: Cleaning agent
 - ▶ Consumpt.: Rinsing agent
 - ▶ Consumpt.: Neutra. agent
 - ▶ ...
 - ▶ Operating hours
 - ▶ Wash cycles
 - ▶ Service interval
- ▶ Report
 - ▶ Short
 - ▶ Long
- ▶ Temperature unit
 - ▶ °C
 - ▶ °F
- ▶ Programme settings
 - ▶ Change programme
 - ▶ ...
 - ▶ Reset programme
 - ▶ ...
- ▶ Air cooling
 - ▶ Yes
 - ▶ No
- ▶ Release programme
 - ▶ All
 - ▶ Selection
 - ▶ ...

Further settings

- ▶ Move programme
 - 1 Universal
 - 2 Standard
 - 3 Intensive
- ▶ Dispensing system
 - ▶ DOS_
 - ▶ Active
 - ▶ Inactive
 - ▶ DOS venting
 - ▶ Concentration
 - ▶ Change name
- ▶ Test programme
 - ▶ No
 - ▶ Laboratory
 - ▶ Validation
- ▶ Interface
 - ▶ Ethernet
 - ▶ ...
 - ▶ RS232
 - ▶ ...
- ▶ Water hardness ⇄ 19
- ▶ Display view
 - ▶ Actual temperature
 - ▶ Required temperature
- ▶ Display
 - ▶ Contrast
 - ▶ Brightness
- ▶ Switch off after
 - ▶ Yes
 - ▶ No
- ▶ Factory default
 - ▶ Reset
 - ▶ Programme settings only
 - ▶ All settings
 - ▶ No
- ▶ Software version
 - ▶ EB ID XXXX
 - ▶ EGL ID XXXX
 - ▶ EZL ID XXXX
 - ▶ EFU ID XXXX

Code

The Further settings menu incorporates relevant functions and system settings which require an enhanced knowledge of machine reprocessing. Access to the menu can therefore be protected by a four digit code.

It is not possible to block individual options or the inputting of multiple codes at the same time.

⚠ If a code is lost, a new code must be issued by Miele Service.

Enter code

If access to the Further settings menu is blocked, you will be prompted to enter the code when it is selected.

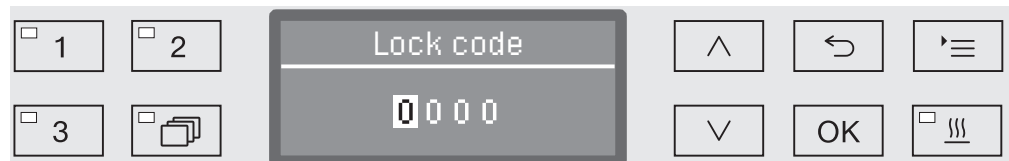

If you do not have the code, contact a user with appropriate access rights or cancel the process using the ↶ button.

- Use the arrow buttons ^ (higher) and v (lower) to enter the relevant digits.
- Confirm each digit individually with the *OK* button.

When the *OK* button is pressed, the display jumps automatically to the next input position. You cannot go back to the previous entry. If a mistake is made, the process must be cancelled using the ↶ button and repeated. Entered digits are replaced by a * symbol.

If all digits are entered correctly the menu will be released.

If an incorrect entry is made, an error message will appear.



- Confirm the message with *OK*.

Access remains blocked and the display reverts to the menu selection.

Further settings

To block cancellation of a programme

A programme which is already running should only be cancelled if strictly necessary, e.g. if the wash load is moving about significantly. Access to the option of cancelling a programme can be blocked using the code.

- Open the menu as follows:

☰ button

▶ Further settings

▶ Code

▶ Cancel programme

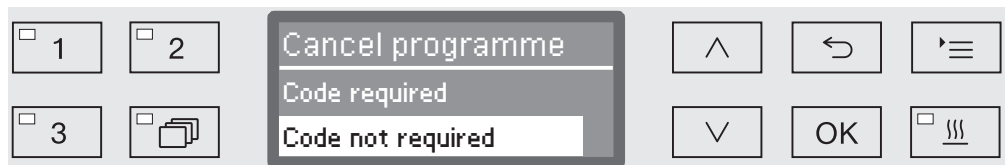

– Code required

A programme can only be cancelled by entering the code.

– Code not required

All users can cancel running programmes at any time.

- Select an option using the ^ and v arrow buttons.
- Press OK to save the setting.

Change code

The code consists of a four digit number and is set by the user. Each digit can be programmed freely between 0 and 9.

⚠ When a new code is entered the old code is overwritten and is permanently deleted. Therefore it cannot be reinstated.
If a code is lost, a new code must be issued by Miele Service.

- Open the menu as follows:

☰ button

▶ Further settings

▶ Code

▶ Change code

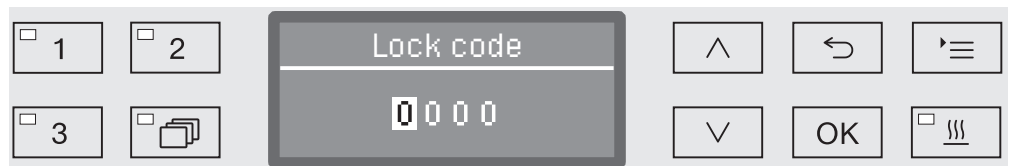

- Use the arrow buttons \wedge (higher) and \vee (lower) to enter the relevant digits.
- Confirm each digit individually with the *OK* button.

When the *OK* button is pressed, the display jumps automatically to the next input position. You cannot go back to the previous entry. If a mistake is made, the process must be cancelled using the \curvearrowright button and repeated. Entered digits are replaced by a * symbol.

The code is saved to memory once you have confirmed the last digit.

Further settings

Log book

The entire life cycle of the machine, including consumption data for water and chemical agents, as well as operating hours and programme cycles are recorded in the log book.

Miele Service can also use the log to calculate a recommendation for service intervals.

- Open the menu as follows:

☰ button

▶ Further settings

▶ Log book

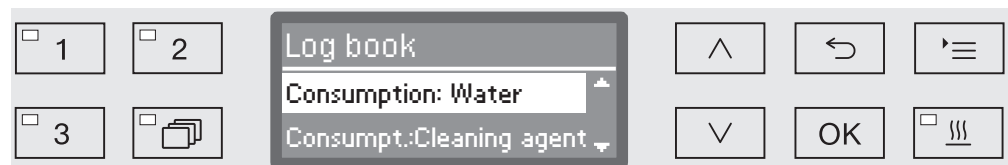

– Consumption: Water

Display the total amount of water used in litres (l).

– Consumpt.:Cleaning agent

Display the total amount of liquid cleaning agent used in litres (l).

– Consumpt.: Rinsing agent

Display the total amount of rinsing agent used in litres (l).

– Consumpt.: Neutra. agent

Display the total amount of neutralising agent used in litres (l).

– Operating hours

Display the total number of operating hours.

– Programme cycle counter

Total of all completed programmes. There is no breakdown of individual programmes. Cancelled programmes are not included.

– Service interval

Date of the next service (entered by Miele Service).

- Select an option using the ^ and v arrow buttons and save your choice with OK.

Values in the machine log cannot be altered.

- Press the ↶ button to exit the menu.

Report

You can choose between two different report formats of process reports for the purpose of archiving.

More information on selecting these can be found in "Process documentation".

Temperature unit

During a programme the temperature display is refreshed every 2 to 5 seconds depending on the programme stage. The temperature can be displayed in degrees Celsius (°C) or Fahrenheit (°F).

The temperature unit is set at the factory to °C.

When the temperature unit is changed to °F, the temperature displayed is automatically recalculated.

- Open the menu as follows:

☰ button

▶ Further settings

▶ Temperature unit

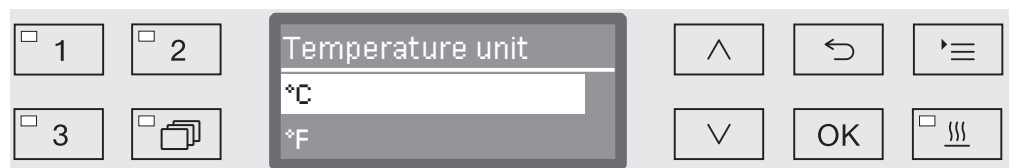

– °C

Display temperature in degrees Celsius.

– °F

Display temperature in degrees Fahrenheit.

- Select an option using the ^ and v arrow buttons.
- Press OK to save the setting.

Further settings

Programme settings

You can use this menu to customise the current programme to suit technical requirements and the wash load or to reset all programmes to the factory default settings.

Additional specialist knowledge is required to alter programme settings and this should therefore be undertaken only by experienced users or by Miele Service.

More information can be found in "Programme settings".

Air cooling

During the drying phase, the hot exhaust air from the wash cabinet is released into the room via the steam condenser. Depending on the size of the room, this can heat up the room to a greater or lesser degree.

To reduce this effect, the heated air can be cooled down during the drying phase using a fine spray in the steam condenser.

Cooling in the steam condenser will increase water consumption.

- Open the menu as follows:

☰ button

▶ Further settings

▶ Air cooling

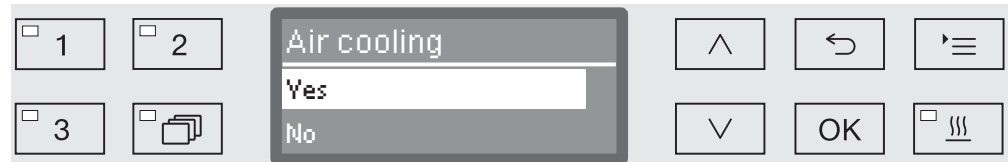

– Yes

Hot air is cooled using the steam condenser.

– No

Hot air is released uncooled into the room.

- Select an option using the ^ and v arrow buttons.
- Press *OK* to save the setting.

Release programme

It is possible to block access to individual programmes. Blocked programmes are not available for selection, so for example it can be ensured that only validated programmes are used.

- Open the menu as follows:

☰ button

- ▶ Further settings
- ▶ Release programme

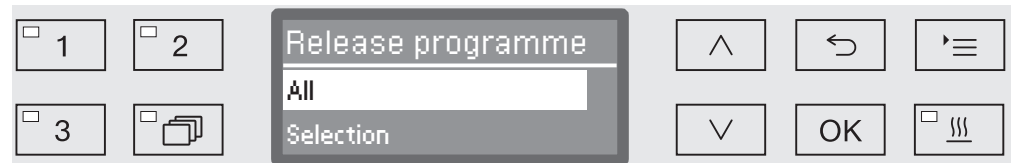

– All

All programmes are released for use.

– Selection

A selection of programmes are available for use.

- Select an option using the \wedge and \vee arrow buttons and confirm your selection with *OK*.

The Selection option displays a list of all programmes.



Programmes are selected by multiple choice. A box is shown next to all programmes in the list. If a programme is released, there is a tick in the box. An empty box indicates a blocked programme.

- Programmes can be released or blocked using the arrow buttons \wedge and \vee and by confirming with *OK*.
- To save the selection select the *Accept* option at the end of the list and confirm with *OK*.

Further settings

Moving a programme: allocating programme selection buttons

You can sort the programme selection list to suit your requirements and therefore also allocate the programme selection buttons 1, 2 and 3.

- Open the menu as follows:

☰ button

▶ Further settings

▶ Move programme



All released programmes are shown in the programme list (see "Further settings / Programme release"). A programme's position in the programme list is decisive for allocating the programme selection buttons. Programmes are numbered from 1 - n. The first three programmes in the list are allocated to the programme selection buttons.

- 1. Universal on programme selection button 1
- 2. Standard on programme selection button 2
- 3. Intensive on programme selection button 3
- 4. Inorganic
- 5. Organic
- etc.

- Use the ^ and v arrow buttons to select the programme you would like to move.

- Confirm your selection with *OK*.

Now you can move this programme within the list.

- Use the ^ and v arrow buttons to move the programme to the position you want.

- Press *OK* to save the programme to the selected position.

The programme which was previously saved to this position and all subsequent programmes are moved down by one position.

The process can be repeated as often as you wish.

- Press the ↶ button to exit the menu.

Dispensing systems

Up to two chemical agents can be dispensed in each wash block. Using the following menu you can activate and vent the dispensing system, change the name if necessary and set the dispensing concentration for all programmes.

Activating dispensing systems

Individual dispensing systems can be activated or deactivated for all programmes as follows.

- Open the menu as follows:

☰ button

▶ Further settings

▶ Dispensing system

▶ DOS... (name of dispensing system)



– Active

The selected dispensing system is activated. Dispensing will only occur in the appropriate wash blocks (see Programme charts).

– Inactive

The selected dispensing system is deactivated for all programmes.

- Select an option using the ^ and v arrow buttons.
- Press OK to save the setting.

Further settings

DOS venting

The dispensing system for liquid chemical agents can only dispense reliably if the system has been purged of air.

The DOS system must only be vented:

- if the dispensing system is being used for the first time,
- if the liquid cleaning agent container was not refilled or replaced in time and the DOS system was sucked dry.

Before venting, ensure that the liquid chemical agent container is sufficiently full and the siphons are securely screwed to the containers. Only one DOS system can be vented at a time.

■ Open the menu as follows:

☰ button

- ▶ Further settings
 - ▶ Dispensing system
 - ▶ DOS... (name of dispensing system)
 - ▶ DOS venting

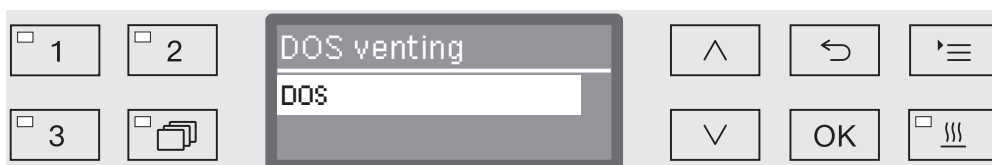

Automatic venting will start when the dispensing system is selected. Once started, the automatic venting process can no longer be cancelled.

- Select a dispensing system using the \wedge and \vee arrow buttons.
- Press *OK* to start the venting process.

Automatic venting is successfully completed when the following message appears in the display:

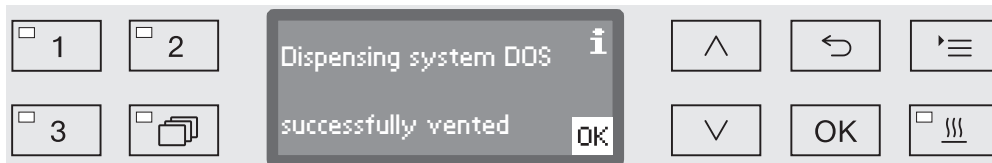

Setting the dispensing concentration for liquid agents

Dispensing concentration for liquid chemical agents, e.g. in the case of a change of manufacturer, can be adjusted for all programmes at once.

Dispensing concentration must be set in accordance with the manufacturer's instructions or with the required processing result.

Consumption of liquid agents is recorded in the log book (see "Further settings / Log book").

Changing programme parameters on a validated machine will necessitate a renewed performance validation.

- Open the menu as follows:

☰ button

- ▶ Further settings
 - ▶ Dispensing system
 - ▶ DOS_
 - ▶ Concentration

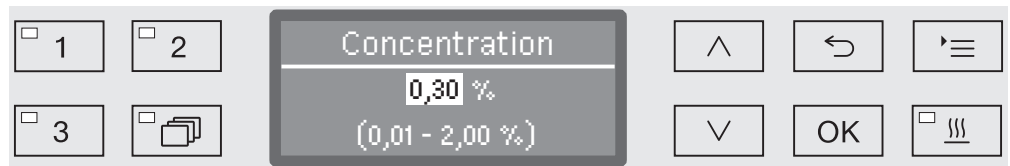

Dispensing concentration can be adjusted in increments of 0.01. The possible range is shown in the bottom line of the display.

- Set the concentration using the arrow buttons \wedge (higher) and \vee (lower).
- Press *OK* to save the setting.

Renaming a dispensing system

If required the names of the dispensing systems "DOS1", "DOS2" etc. can be extended to include additional information e.g. "DOS1 cleaning agent". For more information see "Changing the name". The name "DOS" and the accompanying number cannot be changed.

Test programme

Various programmes are available for monitoring cleaning performance in routine testing.

See "Maintenance" for more information on these programmes.

Further settings

Interface

With Miele washer-disinfectors, cleaning processes can be documented or the Miele Remote Service can be used. To enable this, Miele washer-disinfectors are equipped with a module slot on the back to take a Miele communication module. The communication module is available from Miele and comes with its own operating instructions.

Only use terminal devices (printers etc.) which comply with EN/IEC 60950 (Australia and New Zealand: AS/NZS 60950).

Contact Miele for more information about communication modules, software, suitable printers and the Miele Remote Service.

Ethernet

The XKM 3000 L Med communication module enables the establishment of an Ethernet interface for digital archiving of process data via external software.

The module can be connected to a WLAN network via an existing wireless access point.

RS 232

An XKM RS232 10 Med communication module is required for direct connection to a report printer.

Configuring the interface

 The interface must only be configured by suitably qualified and competent persons.

- Open the menu as follows:

☰ button

▶ Further settings

▶ Interface



– Ethernet

Configuration of an Ethernet interface

– RS232

Configuration of a serial RS 232 interface

- Select the type of interface and confirm your selection with *OK*.

Then the parameters for the interface must be configured.

Further settings

Ethernet

- Status
 - Connection status displayed (On/Off)
- DHCP
 - The Ethernet interface can either be implemented via a Dynamic Host Configuration Protocol (DHCP) or by setting the following parameters:
 - IP address
 - Subnet mask
 - Standard gateway
 - DNS Server automatic
 - DNS Server 1
 - DNS Server 2
 - Port type
 - Port

RS 232

- Print reports
 - Subsequent selection of cycle reports (see "Process documentation").
- Status
 - Connection status displayed (On/Off)
- Language 
 - Any one of the following languages can be set for the RS 232 interface:
 - German
 - English
 - French
 - Italian
 - Spanish
- Interface function
 - Using the interface for process documentation or for the Miele Remote Service via Miele Service.

Water hardness

You can use this menu to set the water softener to the water hardness of the mains supply.

For more information see "Water softener".

Display: Temperature

The wash cabinet temperature can be viewed during a programme. Either the current actual temperature or the required temperature which has been preset for the current wash block is displayed.

- Open the menu as follows:

☰ button

▶ Further settings

▶ Display view



– Actual temperature

Display the current actual temperature in the wash cabinet.

– Required temperature

Display the required temperature which has been preset for the current wash block. If a temperature has not been set, a dotted line --- is shown.

During a programme both settings are displayed together as Temperature. There is no breakdown of actual and required temperature.

- Select an option using the ^ and v arrow buttons.
- Press OK to save the setting.

Further settings

Display brightness and contrast

You can use this menu to adjust the brightness and contrast of the display.

- Open the menu as follows:

▸  button

▸ Further settings

▸ Display



– Contrast

Set the contrast.

– Brightness

Set the brightness.

- Select an option using the \wedge and \vee arrow buttons.

- Confirm your selection with *OK*.

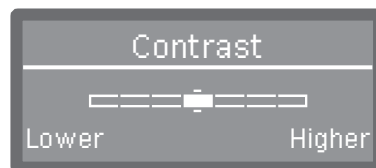

Contrast and brightness are shown as a bar chart in the display.

- Use the arrow buttons \wedge (Higher/Brighter) and \vee (Lower/Darker) to set the brightness and contrast you want.
- Press *OK* to save the setting.

Switch off after (Auto-Off function)

If the machine has not been used for a specific duration, it switches itself off automatically. Automatic switch-off can be optionally activated and deactivated.

- Open the menu as follows:

☰ button

▶ Further settings

▶ Switch off after

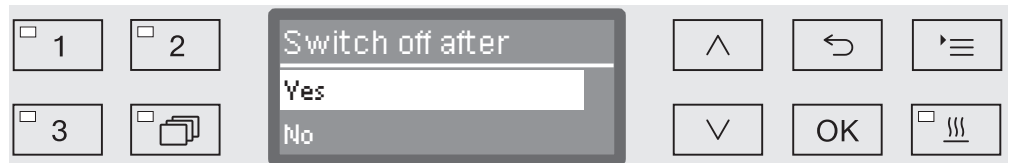

– Yes

The Auto-Off function is activated. A duration must be set after which automatic switch-off should occur.

– No

The Auto-Off function is deactivated.

- Select an option using the \wedge and \vee arrow buttons.
- Press *OK* to save the setting.

Setting the standby duration

If the *Yes* option is displayed, the standby duration after which automatic switch-off should occur must be set next.



The standby duration can be adjusted in 5 minute increments. The possible range is shown in the bottom line of the display.

- Use the \wedge (higher) and \vee (lower) arrow buttons to set the standby duration.
- Press *OK* to save the setting.

Further settings

Factory default

All parameters which have been altered can be reset to their default settings. Control parameters and programme settings are reset separately.

- Open the menu as follows:

☰ button

- ▶ Further settings
 - ▶ Factory default
 - ▶ Reset

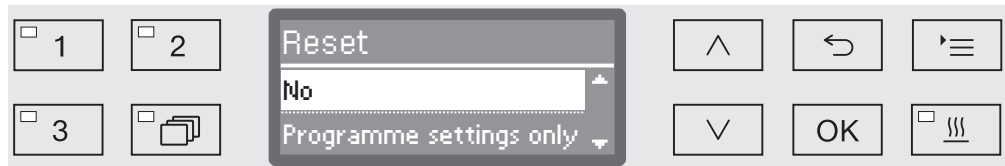

- No
 - Altered parameters are maintained.
- Programme settings only
 - All programme settings are reset.

Programmes saved on free memory locations remain unchanged.

- All settings
 - All control parameters including dispensing quantities and water hardness will be reset.
- Select an option using the ^ and ∇ arrow buttons.
- Confirm your selection with *OK*.

Software version

You can use this menu to call up the software versions of individual elements, e.g. when contacting Miele Service.

For more information see "Service".

Change name

Use this option to document all changes to factory settings in case of a subsequent Service call requirement.

If the option



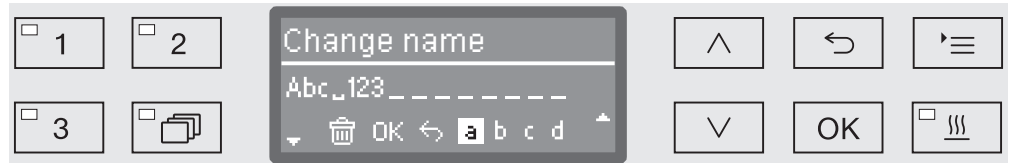

- Change name

has been selected, the display changes to the following view:



The current name is shown on the second line of the display. This can be changed using the options shown in the bottom line. The top line shows which option has been selected from the bottom line.

Names may consist of up to 15 characters including spaces. The following options are available:

- Letters from A to Z, each new word will start with a capital letter.
- Numbers from 0 to 9.
- Space _.
- Use the  symbol to delete the last position.
- The name is saved when the **OK** symbol in the display is selected. The display will then revert to the initial menu.
- The  symbol in the display or the  button end the process without saving the name change. The display reverts to the initial menu.
- Use the arrow buttons  (right) and  (left) to move the cursor to the option you require.
- Confirm each entry with **OK**.

Adjusting programme settings

The programme settings should be adjusted to suit technical requirements and the load.

Additional specialist knowledge is required to alter programme settings and this should therefore be undertaken only by experienced users or by Miele Service.

Changing programme parameters on a validated machine will necessitate a renewed performance validation.

Programme structure

Each programme is subdivided into programme blocks which run one after another. A programme consists of at least one and a maximum of eleven programme blocks. Each block can occur only once in a programme.

The so-called programme header is placed above the programme blocks and contains general programme settings. Individual wash block parameters are also globally activated or deactivated here.

Programme header

- Spray arm monitoring

It is possible to monitor spray arm rotation in selected wash blocks.

- LFMMc max. value

The conductivity of the water in the final rinse phase is monitored using a conductivity measuring module (LFMMc).

- Change volume of water

The water intake quantity can be increased or reduced in each programme. The setting is then valid for all programme blocks including water intake.

- Drain time

If the on-site drainage system is insufficient to drain the waste water from the wash cabinet within the time allocated, the drainage time can be increased.

Programme blocks

Wash block sequence is predefined and is the same as in the programme chart (see "Programme chart").

- Pre-wash 1 to 3

Pre-washing removes coarse soiling and foaming agents, soiling and foam-building substances.

- Main wash 1 and 2

Depending on wash load cleaning generally occurs at temperatures between 40 °C and 60 °C with the addition of appropriate cleaning agent.

- Interim rinse 1 to 4

In the interim rinse stages the chemical agents from the previous wash blocks are rinsed away and neutralised where necessary by the addition of neutralising agents.

- Final rinse 1 to 2

To avoid deposits on the wash load demineralised (AD) water should preferably be used if available for the final rinse.

- Drying

Adequate drying reduces residual moisture on the load.

Programme settings

Opening the menu

The menu for programme settings is locked for users by factory default. If required this can be released by Miele Service.

- Open the menu as follows:

☰ button

- ▶ Further settings
 - ▶ Programme settings



- Change programme

Programmes can be adapted to suit specific technical requirements.

- Reset programme

Reset a programme to factory default settings. Programmes newly installed by Miele Service will be deleted with this option.

Reset programme

Programmes can be individually reset to factory default.

Programmes stored on a free memory location are irretrievably deleted.

- ...
- ▶ Programme settings
 - ▶ Reset programme

All programmes are then listed in the display.

- Use the \wedge and \vee arrow buttons to select the programme and confirm your selection with *OK*.



– Yes

The programme will be reset to factory default.

– No

Programme parameters will not be changed.

- Use the \wedge and \vee arrow buttons to select an option and confirm your selection with *OK*.

Programme settings

Altering a programme

You can alter all parameters which are identified as changeable in the programme charts. Other settings can only be altered by Miele Service.

A programme setting is altered in two steps:

- First the wash blocks must be reallocated to the programme or the existing allocation confirmed again. Only allocated programme blocks can be parameterised.
- Then the programme parameters can be altered.

Use this option to document all changes to factory settings in case of a subsequent Service call requirement.

Changing programme parameters on a validated machine will necessitate a renewed performance validation.

- ...
- ▶ Programme settings
- ▶ Change programme



- Select the programme you want to alter.

For more information see "Allocating wash blocks".

Allocating wash blocks

For every programme change the wash blocks must first be allocated.



Allocation is by multiple choice. A box is shown next to all wash blocks in the display. If a wash block is allocated to the programme, there is a tick in the box. This wash block is allocated to the programme by ticking the box or the allocation can be removed by removing the tick.

- The wash blocks can be selected or deselected using the \wedge and \vee arrow buttons and confirming with *OK*.
- To save the selection select the *Accept* option at the end of the list and confirm with *OK*.
- If you want to adopt the preset wash blocks without any changes, you can confirm the *Accept* immediately with *OK*.

The further setting options will then follow. You can edit these in any order you want.

Programme settings

Spray arm monitoring

The cleaning result depends on the wash water reaching all surfaces and cavities of the wash load. To do this the wash water is distributed throughout the wash cabinet by the rotation of the machine, basket and mobile unit spray arms.

It is possible to monitor the rotation speed of the spray arms during a programme.

The rotation speed is determined using special magnetic spray arms. The sensors of this washer-disinfector cannot detect the magnetic spray arms of older basket and mobile unit models and therefore these cannot be monitored.

If the rotation speed detected is not within a pre-set range, a warning message is shown in the display. This allows e.g., blockages due to loading errors or build-up of foam in the water circulation system to be identified and dealt with promptly.

The rotation speed range depends on the area of application, the programme and the mobile unit or basket used.

If the rotation speed falls short of or exceeds the required spray arm speed, this does not necessitate cancellation of the programme. In fact the programme will - as far as possible - be correctly completed.

In any case, in addition to the error message in the display, this will also be appropriately documented in the cycle documentation.

Switching on spray arm monitoring

Spray arm monitoring is switched on and off globally for all wash blocks.

...

► Spray arm monitoring



– Off

Spray arm monitoring is switched off.

– Off for basket

Only the machine spray arms are monitored. The sensors for baskets or mobile units are deactivated.

– On

All spray arms are monitored.

- Select an option using the ^ and v arrow buttons.
- Press *OK* to save the setting.

Programme settings

Measuring conductivity

Electrical conductivity in a water based solution is a measure of the total amount of dissolved conductive substances (e.g. salts, acids, etc.).

The electrical conductivity during the final rinse phase is relevant for the processing result. Salts and deposits in the water remain on the wash load after drying.

High conductivity in this phase can limit the intended use of processed wash load items.

The conductivity of water used is affected by insufficient / varying quality at the outset, caused by e.g.,

- an empty water softener and / or demineralisation cartridge (optional accessory),
- a ruptured membrane in the reverse osmosis unit (optional accessory),
- on-site work on the water supply,
- transposed plumbing connections after maintenance work,

Possible causes for carry-over of conductive substances from previous wash blocks are e.g.:

- residual used water,
- residual initial contamination,
- residual chemical agents,
- properties of items being processed, e.g. hollow,
- type of load,
- foam.

The conductivity of the final rinse phase is the total of the conductivity of water used in water inflow and the carry-over of conductive substances from the previous wash blocks.

The machine's conductivity meter monitors the conductivity of the wash water. Non-conductive substances, e.g. non-ionic tensides are not detected by the sensor.

Activating conductivity measuring

Conductivity measuring is activated individually for each programme. Conductivity is measured in the final rinse phase.

...

▶ LFMMc max. value

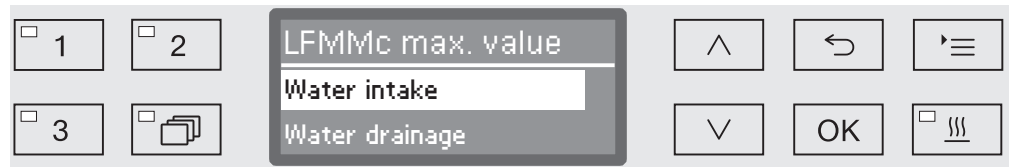

– Water intake

The electrical conductivity of the water before the beginning of the final rinse phase is measured.

– Water drainage

The electrical conductivity of the water at the end of the final rinse phase is measured.

- Select an option using the \wedge and \vee arrow buttons.
- Press *OK* to save the setting.

Following selection a maximum limit value for electrical conductivity must be set.

Set limit value

The limit values for Water intake and Water drainage are set individually.

...

▶ LFMMc max. value

▶ Water intake or Water drainage

▶ Set

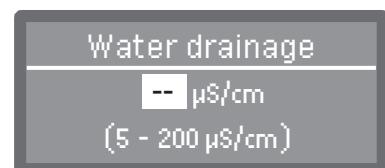
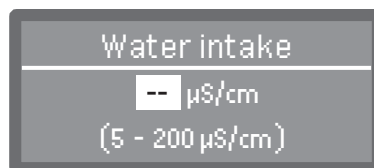

Adjustment is in increments of 1. The possible range is shown in the bottom line.

- Use the arrow buttons \wedge (higher) and \vee (lower) to set the limit value.
- Touch *OK* to save the limit value.

Programme settings

Repeating if limit value is exceeded

If the conductivity exceeds the limit value set, the water intake or the entire wash block can be repeated.

If the measured value is still above the limit following the repetition, the programme is cancelled and an error message is shown in the display and also recorded in cycle documentation.

...

- ▶ LFMMc max. value
 - ▶ Water intake or Water drainage
 - ▶ Number of repeats

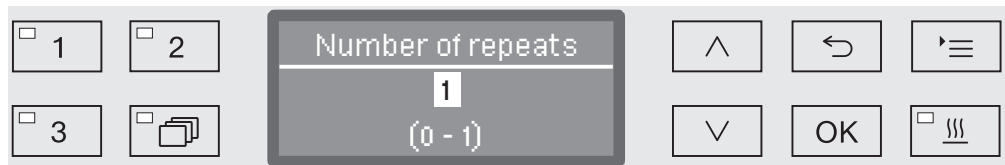

Adjustment is in increments of 1. The possible range is shown in the bottom line.

- Use the arrow buttons \wedge (higher) and \vee (lower) to set the number of repetitions.
- Press *OK* to save the setting.

Calibrating the conductivity meter

The conductivity meter must be recalibrated by Miele Service at regular intervals, e.g. during servicing. Sometimes calibration may also be necessary outside the service cycle.

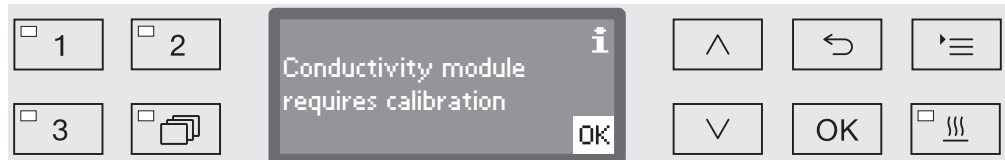

- If this message appears, contact the Miele Service Department.

Activating the conductivity sensor

Conductivity measurement occurs in the Final rinse 1 and Final rinse 2 wash blocks.

...

▶ Monitor LFMMc

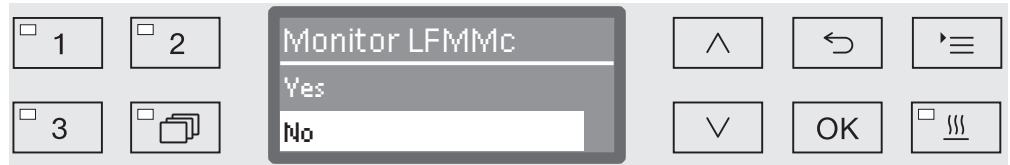

– Yes

Conductivity is measured.

– No

The conductivity sensor is deactivated.

- Select an option using the ^ and v arrow buttons.
- Press *OK* to save the setting.

Programme settings

Change water quantity

Increasing the water level is advisable if a large amount of water clings to items due to the structure of the wash load or if a heavy build-up of foam might occur due to the type of soiling (e.g. blood) and the chemical agents used. The additional amount of water required depends on the type of basket or mobile unit used, the type of soiling and the load.

If a lightly soiled load is being reprocessed which does not hold much water, the amount of water can be reset to the factory default amount to save water and energy.

...
▶ Change volume of water

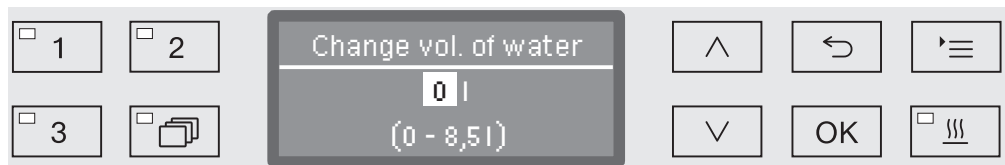

The water quantity can be increased in 0.5 l increments, or set back to the factory default amount. The possible range is shown in the bottom line. The setting "0 l" equates to the factory default setting.

- Use the arrow buttons \wedge (higher) and \vee (lower) to alter the water quantity.
- Press *OK* to save the setting.

Increasing drainage time

If there is still water remaining in the wash cabinet at the end of a wash block, because e.g. the on-site drainage system is inadequate, the following error message will be displayed to enable water to be drained out of the wash cabinet within the designated time:

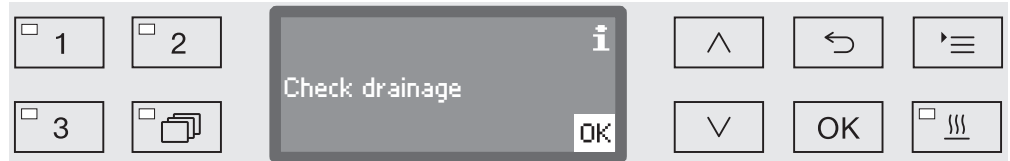

In this case the drainage time can be increased.

...
▶ Drain time



– Standard

The standard drainage time setting applies.

– Increased

Drainage time is increased by a strictly preset increment.

Programme duration will increase with this setting.

- Select an option using the ^ and v arrow buttons.
- Press OK to save the setting.

Programme settings

Setting the concentration level

Up to two chemical agents can be dispensed in each wash block. It is also possible to control the same dispensing system twice.

- ...
- ▶ Dosage 1 or Dosage 2
- ▶ Dispensing system

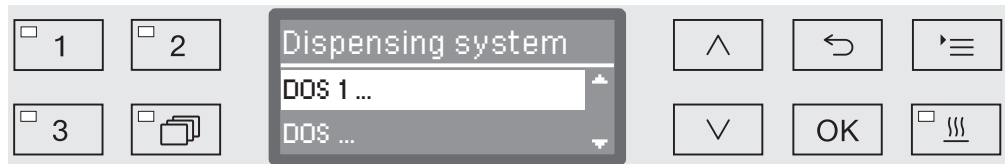

The number of dispensing systems can vary according to model and the number of connected DOS modules.

- Select an option using the \wedge and \vee arrow buttons and save your choice with *OK*.

Then you can set the dispensing concentration in % (percent).

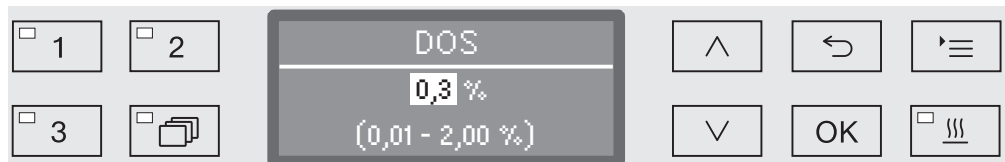

Adjustment is in 0.01% increments. The possible range is shown in the bottom line.

- Use the arrow buttons \wedge (higher) and \vee (lower) to set the dispensing concentration.
- Press *OK* to save the setting.

Set wash block temperature

The wash block temperature is reached by heating up the wash water. The temperature must be suited to the requirements of the task.

At temperatures over 55 °C, protein denaturing occurs which can cause the soiling to fix.
Infection prevention requirements must be observed as appropriate.

...
▶ Wash block temperature

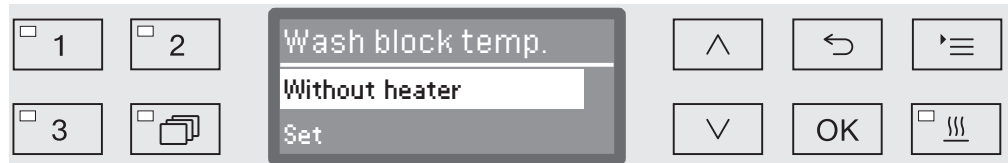

– Without heater

The wash water is not heated up. The temperature in the wash cabinet is the result of the temperature of the previous wash block and the influx of water.

– Set

Setting a wash block temperature.

- Select an option using the ^ and v arrow buttons.
- Press OK to save the setting.

When Set is selected the wash block temperature must then be entered.

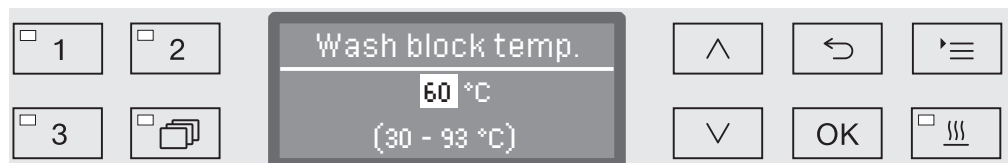

Adjustment is in increments of 1. The possible range is shown in the bottom line.

Dispensing of chemical agents occurs at a default dispensing temperature set at the factory. If chemical agents are to be dispensed in this wash block, the lowest temperature that can be set will be the dispensing temperature. It is not possible to set a lower value.

- Use the arrow buttons ^ (higher) and v (lower) to set the wash block temperature.
- Press OK to save the setting.

Programme settings

Set the holding time

The holding time is the duration in which the wash block temperature is kept constant.

...

► Holding time



The duration can be set in 1 minute increments. The possible range is shown in the bottom line.

If chemical agents are to be dispensed in this wash block, the holding time will equal at least to the DOS exposure time. It is not possible to set a lower value.

- Use the arrow buttons \wedge (higher) and \vee (lower) to set the holding time.
- Press *OK* to save the setting.

Drying unit

The additional "Drying" function accelerates the drying process at the end of the programme.

When the drying function is activated and the door is closed, the drying unit feeds heated and HEPA-filtered air into the wash cabinet for active drying of the load. The heated air is conducted via the steam condenser and can be cooled down if necessary (see "Further settings / Air cooling").

Cooling down pause

A cooling down pause can be incorporated between the end of the final rinse phase and the drying unit starting. During this pause the steam from the wash cabinet is fed into the steam condenser and condensed. This reduces the humidity in the wash cabinet and assists drying.

...

► Cooling down pause

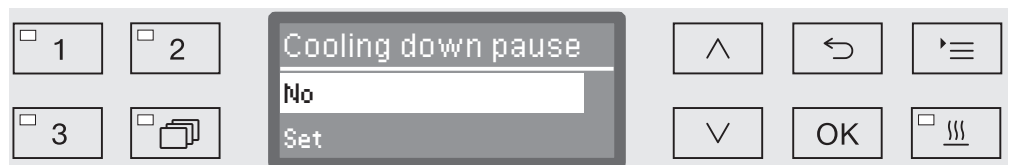

– No

The drying unit starts immediately after the rinse phase without a cooling down pause.

– Set

The cooling down pause is activated for a duration which can be set.

- Select an option using the \wedge and \vee arrow buttons and confirm your selection with *OK*.

When *Set* has been selected, the duration of the cooling down pause must then be set.

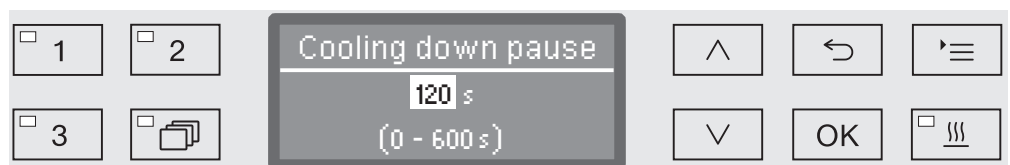

Duration is set in 10 second increments. The possible range is shown in the bottom line.

- Use the arrow buttons \wedge (higher) and \vee (lower) to set the duration of the cooling down pause.
- Press "OK" to save the setting.

Programme settings

Setting the temperature and time

The drying phase is divided into two blocks. The temperature and holding time (Drying time) must be set for each block. The first block (Temperature 1 and Drying time 1) is not allocated to all programmes but can be set up by Miele Service if required.

Set Temperature 1 ...

▶ Temperature 1

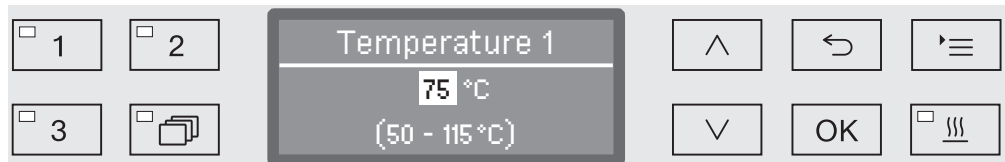

Temperature is adjusted in 5 °C increments. The possible range is shown in the bottom line.

- Use the arrow buttons \wedge (higher) and \vee (lower) to set the temperature.
- Press *OK* to save the setting.

Set Drying time 1 ...

▶ Drying time 1



Holding time is adjusted in 1 minute increments. The possible range is shown in the bottom line.

- Use the arrow buttons \wedge (higher) and \vee (lower) to set the holding time.
- Press *OK* to save the setting.

Set Temperature 2 ...

▶ Temperature 2

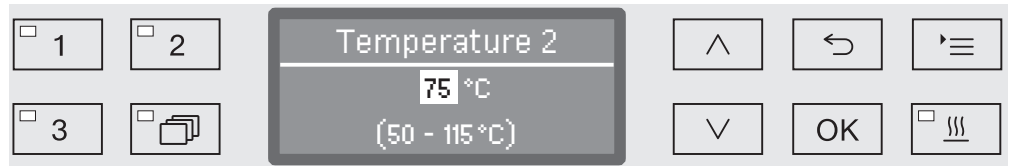

Temperature is adjusted in 5 °C increments. The possible range is shown in the bottom line.

- Use the arrow buttons \wedge (higher) and \vee (lower) to set the temperature.
- Press *OK* to save the setting.

Set Drying time 2 ...

▶ Drying time 2

▶ Set



Holding time is adjusted in 1 minute increments. The possible range is shown in the bottom line.

- Use the arrow buttons \wedge (higher) and \vee (lower) to set the holding time.
- Press *OK* to save the setting.

Programme settings

If required the Drying time can be set again and saved before the start of every programme.

...

▶ Drying time 2

▶ Time changeable?

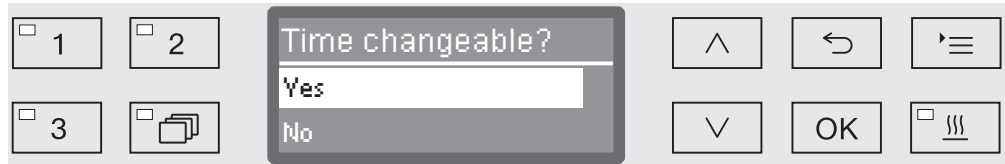

– Yes

Drying time can be set again and saved before the start of every programme.

– No

Drying time cannot be changed.

- Select an option using the ^ and v arrow buttons.
- Press *OK* to save the setting.

Fan cooling

After drying, cooling of the wash load can be accelerated by the drying unit. To do this the drying unit fan runs with the heating switched off, cooling the interior of the wash cabinet.

...

► Cooling down with fan

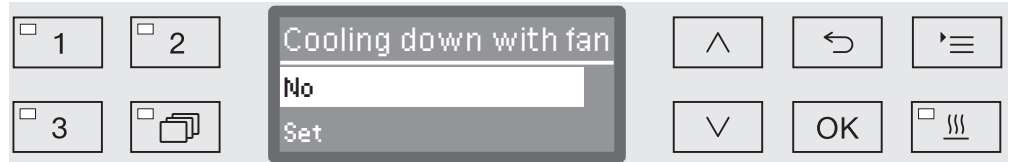

– No

The drying unit fan is not switched on.

– Set

The drying unit fan will run for a specified duration.

- Select an option using the \wedge and \vee arrow buttons and confirm your selection with *OK*.

When *Set* has been selected, the duration of the cooling down pause must then be set.

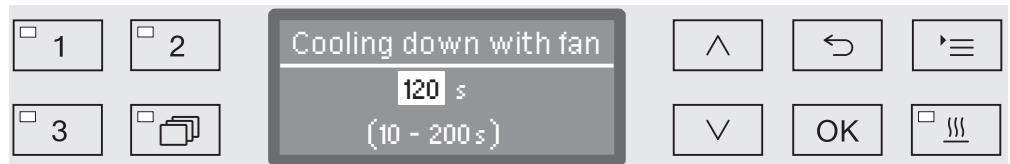

Duration is set in 10 second increments. The possible range is shown in the bottom line.

- Use the arrow buttons \wedge (higher) and \vee (lower) to set the cooling down duration.
- Press "OK" to save the setting.

Documenting processes

Processes are documented per cycle. Required and actual values are always recorded.

During a programme sequence the following data is recorded, among other things:

- Machine type and serial no,
- Date
- Programme start and programme name
- Cycle number
- Blocks used
- Dispensing system, dispensing temperature and required dispensing quantity
- Required values for temperatures and exposure times
- Maximum and minimum temperature during exposure time
- Wash pressure measuring results
- All error messages
- End of programme
- System messages, e.g. refill salt

Further data can be incorporated into the report as required. Contact Miele for more information on this.

Memory

Depending on scale, between 10 and max. 20 cycle reports are stored in an internal power failure safe memory within the machine. In the event of e.g. network or printer problems these can be subsequently recalled. If the memory is full, the oldest report is overwritten.

Raw data for a graphic output of process data from the last programme is also stored. These can be converted into graphics by external documentation software. The transmission of raw data requires an Ethernet interface. Graphic representations in the display or as output to a directly connected printer are not possible. There is no power failure safe memory for graphic information.

Adding cycle numbers

Miele Service can add subsequent cycle numbers, e.g. in the event of software updates or if the machine controls are replaced.

Communication module for external archiving

A module slot is integrated into the back of the machine for a Miele communication module for permanent archiving of cycle reports. The module enables the installation of an Ethernet or RS 232 interface via which the cycle reports can be transmitted to documentation software or a report printer.

Please contact Miele for further information on software and suitable printers.

Only use terminal devices (printers etc.) which comply with EN/IEC 60950 (Australia and New Zealand: AS/NZS 60950).

Communication modules are available from Miele and can be fitted retrospectively at any time. The modules come with their own Installation instructions.

The interface must be configured by suitably qualified and competent personnel. Please refer to the information in "Further settings / Interface".

Process documentation using external software

For digital archiving the process data is transmitted to external documentation software via an Ethernet interface. Transmission can optionally occur continuously during the process or as a single packet at the end of the process. The settings for this are modified by Miele Service.

Information on wash pressure, A_0 value, conductivity and temperature in the wash cabinet can be archived graphically if required.

Installation of an Ethernet interface requires the retrospective fitting of an XKM 3000 L Med communication module.

For connection to a WLAN network the module can be connected via a cable to an existing wireless access point.

Problems with data transmission

If there is a network problem during a running process, e.g. due to a loose cable, a relevant fault message is displayed.

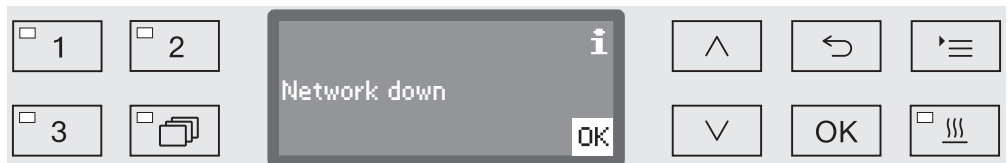

The process running will be continued without interruption and the process data will be saved in the meantime in the internal memory.

In the event of network or report software problems contact your system or network administrator.

Process documentation

Process documentation using a report printer

Process reports are printed via a directly connected report printer and archived on paper. Graphic representations are not included. An XKM RS232 10 Med communication module is required for direct connection.

Report formats

You can choose from two different report formats for paper archiving:

- In long format all recorded data is included.
- Short format includes only selected parameters.

The report format has no effect on the data stored in the washer-disinfector. All the data required for a long report is stored, so the report format can be changed for each new cycle.

- Open the menu as follows:

☰ button

▶ Further settings

▶ Report



- Short

Print in short format

- Long

Print in long format

- Select an option using the ^ and v arrow buttons.
- Press OK to save the setting.

Retrospective output of cycle reports

Internally stored reports can be output retrospectively from the machine.

External software Data can be retrieved directly via the documentation software using an existing network connection. It is not necessary to input entries at the machine itself.

Report printer The following options are available for printing reports retrospectively.

- Open the menu as follows:

☰ button

- ▶ Further settings
 - ▶ Interface
 - ▶ RS232
 - ▶ Print reports

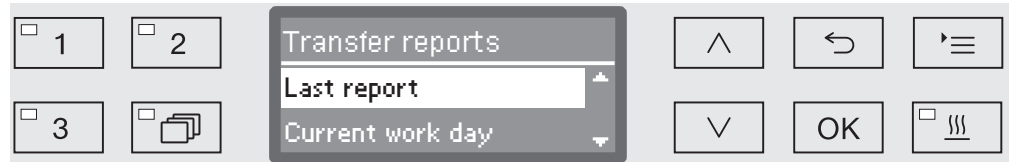

- Last report

Output last cycle report

- Current work day

Output all cycle reports for the current working day

- Last working day

Output all cycle reports for the previous working day

- All

Output all saved reports.

- Select an option using the ^ and v arrow buttons.
- Data transmission is started by pressing the OK button.

Data transmission runs in the background so the machine can go on being used.

Periodic checks

The machine should be serviced **every 1000 hours of operation, or at least once a year** by Miele Service.

This maintenance will cover the following:

- Electrical safety according to national regulations (VDE 0701/0702 in Germany)
- Door mechanism and door seal
- Any screw connections and connectors in the wash cabinet
- Water inlet and drainage
- Internal and external dispensing systems
- Spray arms
- Filter combination
- Sump including drain pump and non-return valve
- All mobile units, baskets, modules and inserts
- Steam condenser
- Wash pressure sensor
- Drying unit
- Conductivity meter

If there is a communication module:

- Any printer connected to the machine
- Network connection

External documentation software and the computer network will not be tested by Miele.

The following operational tests will be carried out within the framework of the maintenance:

- A programme will be run as a test run
- Thermo electrical measurements will be taken
- Seals will be tested for water tightness
- All relevant measuring systems will be safety tested including error message displays.
- Safety features

Routine checks

Before the start of each working day the user must carry out a number of routine checks. A check list is supplied with the machine for this purpose.

The following need to be inspected:

- All filters in the wash cabinet
- The spray arms in the machine and in any mobile units or baskets
- The wash cabinet and the door seal
- The dispensing systems and
- Mobile units, baskets, modules and inserts.

Cleaning the filters in the wash cabinet

The filters in the floor of the wash cabinet prevent coarse soiling from coming into contact with the circulation system. Filters can become blocked by soiling, so they need to be checked every day and cleaned as necessary.

 This machine must not be used without all the filters in place.

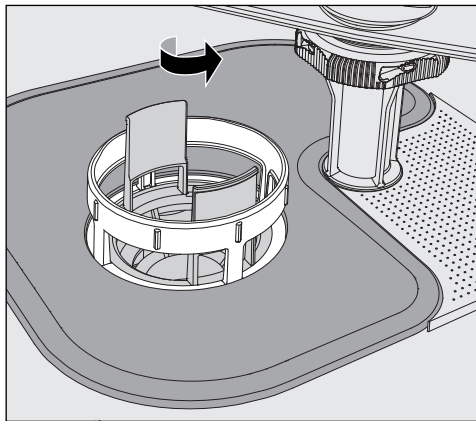

 Danger of injury from glass shards, needles etc which are retained in the filter.

- Turn the microfine filter in the direction of the arrow and remove it together with the coarse filter.

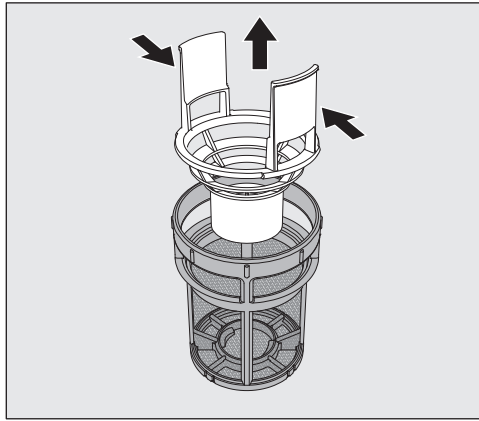

- Press the catches towards each other and pull the coarse filter upwards to remove it.
- Remove the fine filter which sits loosely between the coarse filter and the microfine filter.

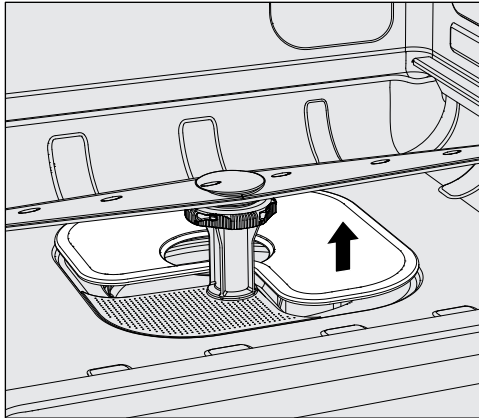

- Remove the flat filter last.
- Clean the filters.
- Re-insert the filter combination in the reverse order. Ensure ...
 - ... that the flat filter sits flat in the base of the wash cabinet.
 - ... that the coarse filter has securely clicked into place in the microfine filter.
 - ... that the microfine filter is tightly screwed in as far as it will go.

Cleaning the spray arms

The spray arms can become blocked, especially if the filters are not inserted correctly in the wash cabinet. This can cause coarse particles of soiling to get into the wash fluid circulation.

The spray arms must be visually checked daily for any soiling.

- To do this remove the mobile unit and the baskets.
- Visually check the spray arms for soiling and blocked jets.
- Also check that the spray arms can turn easily.

⚠ Immobile or blocked spray arms must not be used again.
In this case contact Miele Service.

Cleaning the spray arms

The spray arms in the machine as well as in the mobile units and baskets must be fully dismantled for cleaning:

- Remove the mobile unit or baskets from the machine.

The machine upper spray arm is connected by a push-fit connector.

- Pull the machine upper spray arm downwards to remove it.

The machine lower spray arm and the spray arms in the mobile units and baskets are secured with bayonet fittings.

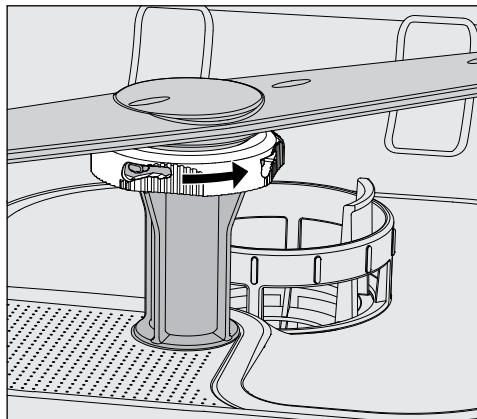

- To release the knurled bayonet fittings, turn them in the direction of the arrow as far as they will go.
- Then the spray arms can be removed by pulling them upwards or downwards.

Mobile unit and basket spray arms with knurled nuts:

The spray arms of older types of mobile units and baskets are secured with knurled nuts. These must be unscrewed and the spray arms pulled downwards to remove them.

Metal knurled nuts have a left-hand thread.

Ceramic knurled nuts have a right-hand thread.

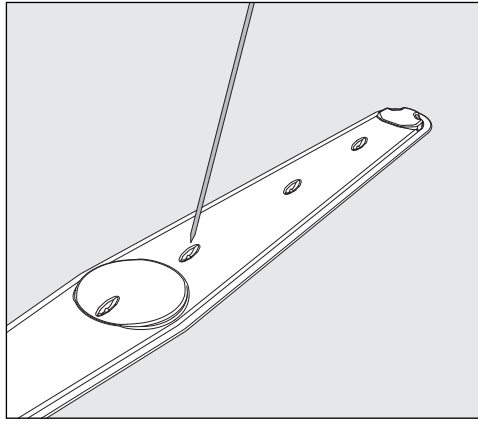

- Use a pointed object to push food particles into the spray arm.
- Rinse the spray arm thoroughly under running water.

⚠ Do not allow any magnetic objects or wash items stick to the magnets on the spray arms.
Any metallic objects on the magnets can cause a false reading of spray arm pressure.
Remove all metallic objects from the magnets.

- Check the spray arm bearings for visible signs of wear.

Visible wear on the bearings can adversely affect the long-term functioning of the spray arms.
In this case, contact Miele Service.

- Replace the spray arms after cleaning.
- Make sure the spray arms can rotate easily after they have been fitted.

The spray arms and baskets each have a number e.g. 03, which is also embossed on the water supply pipes near the bayonet fittings. When refitting, ensure that the numbers on the spray arms correspond with the numbers on the water supply pipes.

Cleaning the machine

⚠ Never clean the machine or near vicinity with a water hose or a pressure washer.

⚠ Do not use cleaning agents containing ammonia or thinners on stainless steel surfaces!

These agents can damage the surface material.

Cleaning the control panel

Do not use any abrasive materials or general-purpose cleaners to clean the control panel.

These can cause considerable damage to the glass and plastic surfaces and to the onset control buttons.

- Clean the control panel with a damp cloth and a little washing-up liquid or with a non-abrasive stainless steel cleaner.
- Proprietary glass or plastic cleaning agents can also be used to clean the display.
- For surface disinfection use a listed agent recommended by the manufacturer.

Cleaning the door and the door seal

- Wipe the door seal regularly with a damp cloth to remove soiling. Have damaged or leaking door seals replaced by Miele Service.
- Remove any soiling from the door sides and hinges.
- Regularly clean the groove in the plinth panel under the door with a damp cloth.

Cleaning the wash cabinet

The wash cabinet is largely self-cleaning, however if deposits should start to build up, contact Miele Service.

Cleaning the door front

- To clean the stainless steel front, use a damp cloth with a solution of washing-up liquid and hot water, or with a non-abrasive cleaning agent for use on stainless steel.

Preventing re-soiling

- To help prevent re-soiling of stainless steel surfaces (fingerprints, etc.), a suitable stainless steel conditioner can be used after cleaning.

Checking mobile units, baskets, modules and inserts

Mobile units, baskets, modules and inserts should be checked daily to make sure they are functioning correctly. The machine is supplied with a check list.

Check the following points:

- Are the mobile unit or basket rollers in good condition, and are they securely attached to their mobile units or baskets?
- Are the water connectors present and undamaged?
- Are height-adjustable water connectors adjusted to the correct height and securely fixed?
- Are all injector nozzles, irrigation sleeves and hose adaptors securely attached to mobile units/inserts?
- Are all injector nozzles, sleeves, and hose adapters clear so that wash fluid can flow through unhindered?
- Are all caps and fasteners securely attached to the irrigation sleeves?
- Are end caps present and securely located for all modules and injector manifolds?
- Are the locking caps in the water connectors of mobile units and baskets working properly?

and where applicable:

- Make sure that the spray arms rotate freely.
- Make sure the spray arm jets are free of any blockages. See "Cleaning the spray arms".
- Make sure that the magnets integrated into the spray arms have no metallic objects sticking to them.
- Check whether the tubular filters need to be cleaned or filter plates, e.g. in an E 478/1 need to be replaced.

Maintenance of mobile units, baskets, modules and inserts

The machine should be serviced **every 1000 hours of operation, or at least once a year** by Miele Service.

Filter change

The air filter for the internal drying unit has a limited lifespan and has to be replaced at regular intervals, e.g. when the following message appears:

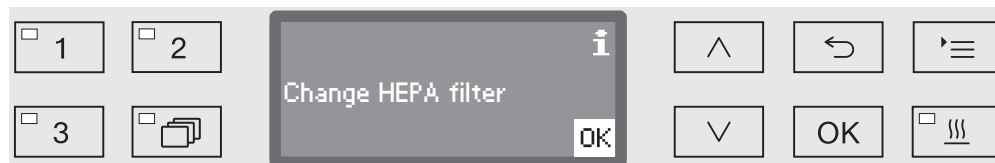

Changing the coarse filter

- Open the drawer in the side unit.

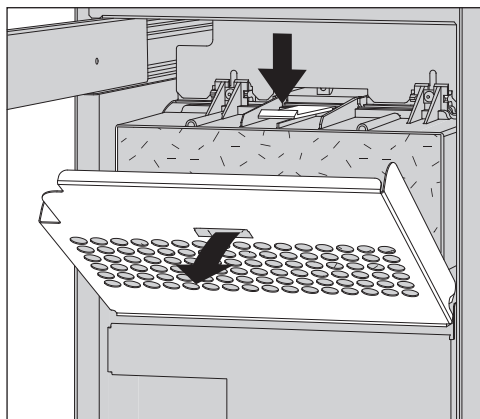

- Release the filter grille and swing it downwards to open. The grille can also be removed completely.

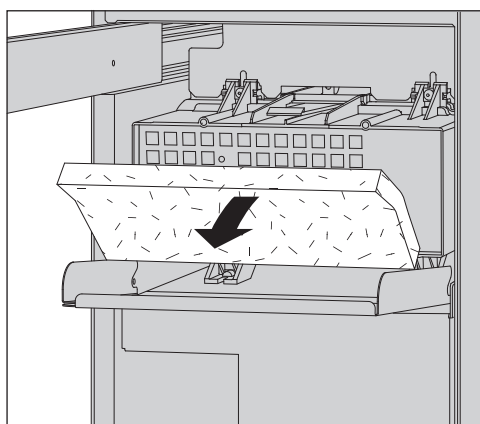

- Change the coarse filter. The soft side of the filter must be to the front.
- Replace the filter grille and close the side unit drawer.

Whenever the coarse filter is replaced the operating hours counter must be reset (see "Resetting the operating hours counter").

Maintenance

Changing the HEPA filter

Replace with an **Original Miele HEPA filter classification 13** for optimum performance.

If possible the HEPA filter should be changed by Miele during a service. If this is not possible, proceed as follows to change the filter:

- Open the side unit drawer and remove the filter grille and coarse filter.

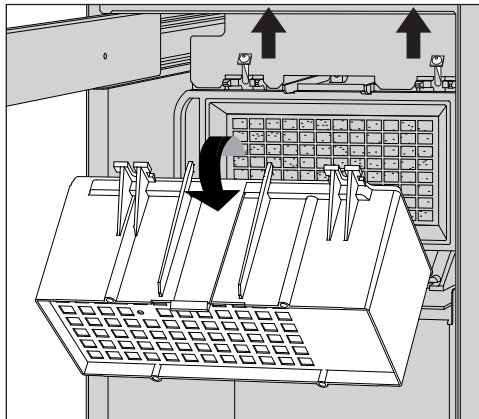

- Undo the screws securing the coarse filter housing and swing it upwards.
- Remove the coarse filter housing.

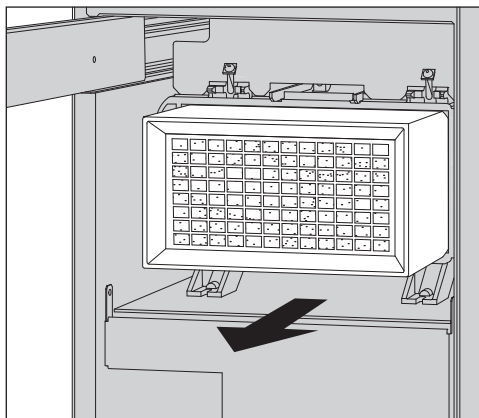

- Remove the HEPA filter from its holder and insert a new one.
- Replace the coarse filter housing and tighten the securing screws.
- Replace the coarse filter and the filter grille and close the side unit drawer.

Whenever the HEPA filter is replaced the operating hours counter must be reset (see "Resetting the operating hours counter").

Resetting the operating hours counter

The maximum permissible number of operating hours is pre-set in the controls for all filters. After a filter has been changed the operating hours counter must be reset.

- Open the menu as follows:

☰ button

▶ Settings

▶ Change the filter

▶ Coarse filter or HEPA filter

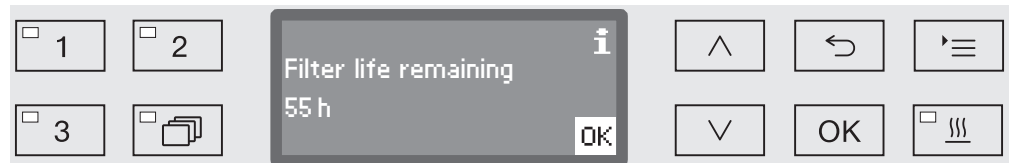

The remaining operating hours for this filter type is shown in the display.

- Confirm the message with *OK*.

Then you will be asked if you wish to reset the operating hours counter.

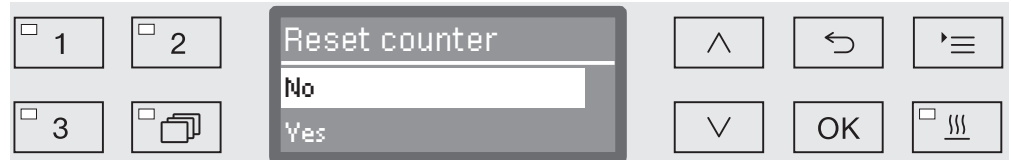
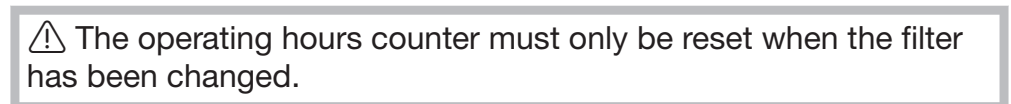

– No

The counter will not be reset.

– Yes

The operating hours counter will be reset for the new filter.

- Select an option using the ^ and v arrow buttons.
- Confirm your selection with *OK*.

Performance check

Adequate processing performance must be regularly confirmed by the user.

Test point for measuring sensors

On the top of the machine, at the front right under the lid or worktop is the test point for validation purposes. To gain access to this the lid of the washer-disinfector must be removed or the washer-disinfector must be pulled out from under the worktop.

- Open the door.

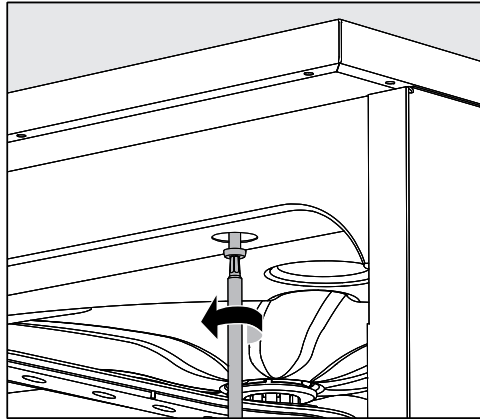

- Unscrew the fixing screws.
 - Then remove the safety screws on the back of the machine from the **lid** and lift the **lid** to remove it.
- or
- Pull the washer-disinfector out by approx. 15 cm from under the **worktop**.

Test programmes There are various programmes for testing cleaning performance in the course of routine testing. The test programmes are not independent processing programmes, but additional functions which can be activated before the start of any processing programme.

The test programmes interrupt the programme sequence automatically at specified points for 30 seconds. An audible tone sounds and a message is displayed. Within this time measurements can be taken or the door can be opened to take test samples. To prevent the wash cabinet from cooling down do not leave the door open for too long.

The programme will recommence after the 30 seconds has elapsed. If the door was opened, the programme can only restart when the door is closed.

If you do not want to take measurements or samples, you can advance the programme early by pressing the *Start/Stop* button.

The following test programmes can be selected:

- Laboratory

The programme sequence can be paused in each wash block immediately before the wash fluid is drained away.

- Validation

The programme sequence is interrupted at the following points:

- before the wash fluid is drained away in the final wash block and
- after water inlet and before draining in the final rinse block.

Maintenance

Activating a test programme

Test programmes are valid for only one programme sequence each time. A test programme must be selected again for further tests.

- Open the menu as follows:

☰ button

▶ Further settings

▶ Test programme

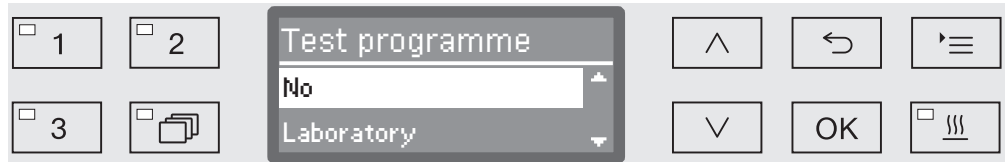

– No

The menu is exited without selecting a programme.

– Laboratory

Activates the Laboratory test programme

– Validation

Activates the Validation test programme

- Select an option using the ^ and v arrow buttons.

- Press *OK* to activate the test programme for the next programme start.

You can now start the performance test.

- Select and start a programme using the programme selection buttons or via the programme list.

The programme will be identified in the bottom line as Test programme during the programme sequence.

If you want to deactivate the test programme before the performance test you need to go to the next menu level up and select the No option.



The following guide may help you to find the reason for a fault, and to correct it. You should, however, note the following:

 Repairs may only be carried out by Miele Service.
Repairs and other work by unqualified persons could be dangerous for the user.

To avoid unnecessary service call-outs, check that the fault has not been caused by incorrect operation when an error message first appears.

For all fault messages:
If the cause is not remedied and the machine is switched off, when it is switched back on again the fault message must be acknowledged with the code. The machine will be locked for further use until this is done.

Technical faults and messages

Problem	Cause and remedy
The display is dark and all LEDs are out.	The machine is not switched on. ■ Switch the machine on using the  button.
	A fuse is defective or has tripped ■ Minimum fuse rating - see data plate. ■ Reset the trip switch. ■ If the mains fuse trips again, call Miele Service.
	The machine is not plugged in, or connected to the mains. ■ Plug the machine in and connect it to the mains supply.
The machine has switched itself off.	This is not a fault. The Auto-Off function switches the machine off automatically after a pre-set duration to save energy. ■ Switch the machine on using the  button.
Next service due on:	This is not a fault. Miele Service has recommended a date for the next service visit. ■ Please contact the Miele Service Department to arrange a service visit.

Problem solving guide

Dispensing / dispensing systems

⚠ Caution when handling chemical agents.

For all chemical agents, the chemical agent manufacturer's safety instructions as given on their safety data sheets must be observed.

Problem	Cause and remedy
DOS Refill	<p>During a programme sequence a low level of liquid chemical agent in a container has been identified.</p> <ul style="list-style-type: none"> ■ Refill the container before the start of the next programme or exchange it for a full container.
DOS Vent at end of programme	<p>During a programme an uneven flow rate of a liquid chemical agent has been identified. There may be air in the dispensing system.</p> <ul style="list-style-type: none"> ■ Allow the programme to continue to the end. ■ Vent the dispensing system at the end of the programme.
Programme could not be started. Vent DOS	<p>A programme cannot be started because ...</p> <p>... there is air in the dispensing system.</p> <p>... the dispensing system has been sucked completely dry.</p> <ul style="list-style-type: none"> ■ Check the level in the supply container and refill or replace it with a full container as necessary. ■ Vent the dispensing system.
Dispensing system DOS venting	<p>This is not a fault.</p> <p>The dispensing system will now be automatically vented.</p> <p>Wait until the venting process is finished.</p>
Venting DOS cancelled. Venting must be repeated	<p>Venting of the dispensing system was cancelled because an insufficient flow rate has been identified. A dispensing hose may be kinked or the siphon blocked.</p> <ul style="list-style-type: none"> ■ Check the dispensing hose for kinks and leaks. Position it so that it cannot become kinked. ■ Check the suction aperture of the siphon for blockages and remove these as necessary. ■ Start the venting process again. <p>Contact Miele Service if there are leaks in the dispensing hose or a fault with the siphon.</p>

Problem	Cause and remedy
Check container/lance DOS	<p>Little or no flow has been identified.</p> <ul style="list-style-type: none"> ■ Check the level in the supply container and refill or replace it with a full container as necessary. ■ Check the suction aperture of the siphon for deposits. ■ Vent the dispensing system.
	<p>The dispensing hose is blocked.</p> <ul style="list-style-type: none"> ■ Remove any kinks from the dispensing hose. Position it so that it cannot become kinked. ■ Check the dispensing hose for leaks. ■ Vent the dispensing system. <p>Contact Miele Service if there are leaks in the dispensing hose or a fault with the siphon.</p>

Highly viscous (thick) chemical agents can affect the dispenser monitoring and lead to inaccurate data. In this instance please contact Miele Service for advice.

The viscosity does not affect dosage concentration levels.

Problem solving guide



Insufficient salt / Water softener

Problem	Cause and remedy
Refill salt	Salt is running low in the water softener. ■ Refill the reactivation salt before starting the next programme.
Machine locking out Insufficient salt	Salt in the water softener is completely depleted and reactivation is no longer possible. The machine is locked for further use. ■ Refill the reactivation salt.
Salt container empty, Programme locked out	The water softener cannot reactivate because there is insufficient salt. The machine is locked for further use. ■ Refill the reactivation salt. The lock is lifted a couple of seconds after refilling the salt reservoir. Reactivation will occur automatically during the next programme.
Salt container lid not correctly closed	The salt container is not closed properly. ■ Close the container properly.
	Salt residues are preventing it from closing. ■ Remove the residues from the refilling funnel, the lid and the seal. ■ Close the container properly.

Cancel with fault code

If a programme is cancelled and a fault code appears, e. g. Fault XXX (whereby XXX represents a number), there could be a serious technical fault.

In the event of a programme being cancelled and a fault number being shown:

- Switch the machine off using the  button.
- Wait approximately 10 seconds before switching the machine on again with the  button.
- Acknowledge the fault code by entering your lock code.
- Start the previously selected programme again.

If the same message appears again:

- Make a note of the fault message
- Switch the machine off using the  button.
- Contact the Miele Service Department.

Please also read the notes regarding the following fault numbers:

Problem	Cause and remedy
Fault 403-405	<p>A programme has been cancelled because water intake by the machine was insufficient or severely restricted.</p> <ul style="list-style-type: none"> ■ Open the stopcocks fully. ■ Follow the further information given in the Check water inlet message.
Fault 406-408	<p>A programme was cancelled because the water intake volume is insufficient.</p> <ul style="list-style-type: none"> ■ Check whether the stopcocks are fully opened. ■ Refer to the information regarding minimum flow pressure in "Plumbing" and "Technical data". ■ Check the filter in the water inlet. ■ Contact Miele Service for advice.
Fault 412-414	<p>A programme was cancelled because the water intake volume is too high.</p> <ul style="list-style-type: none"> ■ Refer to the information regarding recommended maximum flow pressure and maximum permissible static water pressure in "Plumbing" and "Technical data". ■ Contact Miele Service for advice.
Fault 433	<p>Protruding wash load items are preventing the door from being closed properly by the Comfort lock.</p> <ul style="list-style-type: none"> ■ Sort the wash load so that that it does not obstruct the door. ■ Close the door.

Problem solving guide

Problem	Cause and remedy
Fault 440	<p>The float switch in the base of the machine has not been activated. The switch might be blocked.</p> <ul style="list-style-type: none"> ■ Remove the filter combination. ■ Check the float switch to make sure it moves freely. The float switch is located in the base of the machine behind the spray arm.
Fault 460-462	<p>The programme has been cancelled because of a blocked spray arm.</p> <ul style="list-style-type: none"> ■ Arrange the load so that the spray arms can turn easily.
Fault 518	<p>No flow was detected when dispensing from an external supply container.</p> <div style="border: 1px solid black; padding: 5px; margin: 10px 0;"> <p> Caution when handling chemical agents. For all chemical agents, the chemical agent manufacturer's safety instructions as given on their safety data sheets must be observed.</p> </div> <ul style="list-style-type: none"> ■ Check the level of the container and refill or replace it as necessary. ■ Check the suction apertures of the siphons and remove any deposits. ■ Check the hose connections on the siphons, the machine and any DOS modules. ■ Remove any kinks from the dispensing hoses and check the hoses for leaks. Position the dispensing hoses so that they cannot kink. ■ Vent the dispensing system <p>If you identify any leaks in the dispensing hoses or defects on the siphons contact Miele Service.</p>
Fault 526	<p>Minimum flow pressure was not reached because one or more free water connectors in the back panel of the wash cabinet is not properly secured.</p> <ul style="list-style-type: none"> ■ Check the washers in the water connectors in the back panel of the wash cabinet and remove any blockages.





Process-related faults and messages

Problem	Cause and remedy
Change the coarse filter	<p>The maximum permissible operating hours for the coarse filter have been reached.</p> <ul style="list-style-type: none"> ■ Replace the coarse filter with a new one. ■ Reset the operating hours counter for the coarse filter.
Change HEPA filter	<p>The maximum permissible operating hours for the HEPA filter have been reached.</p> <ul style="list-style-type: none"> ■ Replace the HEPA filter with a new one. ■ Reset the operating hours counter for the HEPA filter.
Drying during programme deactivated	<p>Drying cannot be selected at the start of a programme because drying is not available for the selected programme.</p> <ul style="list-style-type: none"> ■ Start the programme without drying. <p>or</p> <ul style="list-style-type: none"> ■ Have the drying parameters for this programme adjusted by Miele Service.
Wrong code entered	<p>The code entered is not the same as the code saved.</p> <ul style="list-style-type: none"> ■ Enter the code again. ■ Report the loss of the code to Miele Service.
Test programme: test object can now be removed	<p>This is not a fault.</p> <p>A test programme is running to check performance. At certain points in the programme the sequence is interrupted so that samples can be taken.</p> <ul style="list-style-type: none"> ■ Take a sample. <p>or</p> <ul style="list-style-type: none"> ■ Wait. The programme will continue automatically in approx. 30 seconds. <p>or</p> <ul style="list-style-type: none"> ■ Continue the programme without delay by pressing the <i>Start/Stop</i> button.
Programme cancelled	<p>This is not a fault.</p> <p>A programme which was running was cancelled by the user.</p> <div style="border: 1px solid black; padding: 5px; margin-top: 10px;"> <p> The wash cabinet interior can be very hot. When the door is opened, hot steam and chemical agents can escape. Protective measures for personal safety must be observed.</p> </div>
Programme continued	<p>This is not a fault.</p> <p>The process of cancelling a programme was not completed.</p> <p>The programme which was running continued without interruption.</p>

Problem solving guide

Problem	Cause and remedy
All settings reset	This is not a fault. A user has restored factory default settings. ■ Confirm the message with <i>OK</i> .
All programme settings reset	This is not a fault. A user has restored the factory default setting for the programme. ■ Confirm the message with <i>OK</i> .

Door

Problem	Cause and remedy
Door not closed properly	<p>Protruding wash load item obstructing the door.</p> <ul style="list-style-type: none"> ■ Sort the wash load so that that it does not obstruct the door. ■ Close the door. <p>Slamming the door can result in problems with the Comfort door lock.</p> <ul style="list-style-type: none"> ■ Open and close the door. <p>If the same message appears again:</p> <ul style="list-style-type: none"> ■ Contact the Miele Service Department.
Warning. Cabinet hot! Open anyway?	<p>When the  button is pressed, the temperature in the wash cabinet is over 70 °C.</p> <div style="border: 1px solid gray; padding: 5px; margin: 5px 0;"> <p> When the door is opened, hot steam and chemical agents can escape!</p> </div> <ul style="list-style-type: none"> ■ Open the door only when strictly necessary.
Door blocked	<p>Heavy objects in front of the washer-disinfector can impede the automatic opening of the door by the Comfort lock.</p> <ul style="list-style-type: none"> ■ Do not place heavy objects in front of the door of the washer-disinfector. <p>The Comfort door lock is blocked.</p> <ul style="list-style-type: none"> ■ Try to open the door carefully (without using force) by pulling on the door handle. <p>If the door is still blocked:</p> <ul style="list-style-type: none"> ■ Open the door using the emergency release. ■ Close the door and try to open it again using the  button. <p>If it is still blocked:</p> <ul style="list-style-type: none"> ■ Contact the Miele Service Department.
Emergency release	<p>The door was opened using the emergency release.</p> <ul style="list-style-type: none"> ■ See "Opening the door using the emergency release".
The door is open a fraction and cannot be closed using the  button.	<p>This is not a fault.</p> <p>The Comfort door lock has opened the door slightly at the end of the programme.</p> <ul style="list-style-type: none"> ■ Open the door. The door can now be closed completely again using the  button.

Problem solving guide

Unsatisfactory cleaning and corrosion.

Problem	Cause and remedy
There are white deposits on the wash load.	The water softener is set too low. ■ Set the water softener to the correct water hardness.
	There is no salt in the salt reservoir. ■ Refill the reactivation salt.
	The quality of the water for the final rinse was insufficient. ■ Use water with a low conductance value. ■ If the machine is connected to a water softening cartridge, check it and replace as necessary.
	The water from the AD water connection is not sufficiently softened. ■ Check the pre-selected water softening units. If necessary, replace the water softening cartridge with a new one.
The cleaning result is unsatisfactory.	Mobile units, baskets, modules and inserts were not suitable for the load. ■ Select mobile units, baskets, modules and inserts which are suitable for the task.
	Mobile units, baskets, modules and inserts were incorrectly loaded or overloaded. ■ Arrange the wash load correctly according to the information in the operating instructions. ■ Avoid overloading the mobile units, baskets, modules and inserts.
	The programme was not suitable for the soiling. ■ Select a suitable programme. or ■ Adjust the parameters to suit the task.
	A spray arm is blocked. ■ Ensure the spray arms are not obstructed when arranging the wash load.
	Injector nozzles on the mobile units, baskets, modules or inserts are blocked. ■ Check the nozzles and clean them as necessary.
	The filters in the wash cabinet are dirty. ■ Check the filters and clean them if necessary.
	Mobile units, baskets or modules were not correctly docked to the water connection. ■ Check the connection.

Problem	Cause and remedy
Items made of glass are showing signs of corrosion.	The items are not suitable for machine reprocessing. ■ Only use items which are declared by their manufacturer as suitable for machine reprocessing.
	Neutralisation has not taken place during the programme. ■ Check the level in the supply container and vent the dispensing system if necessary.
	The wash temperature was too high. ■ Select a different programme. or ■ Reduce the wash temperature.
	Cleaning agents used were too alkaline. ■ Use a milder cleaning agent. or ■ Reduce the concentration of the cleaning agent.
Stainless steel items are showing signs of corrosion.	The stainless steel is of insufficient quality for machine reprocessing. ■ Only use stainless steel items made of high quality stainless steel and follow the instructions of the manufacturer regarding machine reprocessing.
	The chloride content in the water is too high. ■ Have a water analysis check carried out. Connection to an external water processing unit and the use of demineralised water may be necessary.
	Neutralisation has not taken place during the programme. ■ Check the level in the supply container and vent the dispensing system if necessary.
	Rust or superficial rust has built up in the wash cabinet, e.g. due to an excessively high iron content in the water or rust on other wash load items. ■ Check the installation. ■ Discard any rusty items.

Problem solving guide

Spray arm monitoring / conductivity / wash pressure

Problem	Cause and remedy
Spray arm monitoring - upper wash cabinet: Spray arm blocked or excessive foaming or Spray arm monitoring - lower wash cabinet: Spray arm blocked or excessive foaming or Spray arm monitoring - mobile unit spray arm 1 - : spray arm blocked or excessive foaming	The rotation speed set has not been reached because... <ul style="list-style-type: none"> - items are obstructing the machine or basket spray arms. <ul style="list-style-type: none"> ■ Arrange the load so that the spray arms can turn easily and start the programme again. - the relevant spray arm is blocked. <ul style="list-style-type: none"> ■ Clean the spray arm. ■ Check whether the filters in the wash cabinet are clean and correctly inserted. ■ Start the programme again. - wash pressure is too low due to a heavy build-up of foam. <ul style="list-style-type: none"> ■ Follow the instructions regarding foam build-up in "Chemical processes and technology".
Conductivity level too high: Actual value: $\mu\text{S}/\text{cm}$ Max value: $\mu\text{S}/\text{cm}$	Carry-over of conductive substances during reprocessing. <ul style="list-style-type: none"> ■ Check the process.
	Empty or faulty water softener or demineralisation system. <ul style="list-style-type: none"> ■ Check external water softener or demineralisation systems. ■ Reactivate the systems if necessary.
	Work on the on-site water supply. <ul style="list-style-type: none"> ■ Contact a suitably qualified plumber.
	Plumbing connections transposed. <ul style="list-style-type: none"> ■ Observe the markings on the plumbing connections (see "Connection to the water supply").
Conductivity level exceeds max. value	Conductivity value cannot be determined because the value is out of range (too low). <ul style="list-style-type: none"> ■ Contact the Miele Service Department.
Conductivity module requires calibration	The conductivity meter must be recalibrated. <ul style="list-style-type: none"> ■ Contact the Miele Service Department.
Conductivity module communication error	The connection to the conductivity module is disrupted. <ul style="list-style-type: none"> ■ Contact the Miele Service Department.
Spray pressure exceeds tolerance	The spray pressure has deviated by more than 20% from the mean value. Reasons for fluctuations in wash pressure are e.g.: <ul style="list-style-type: none"> - defective water connections, - open adapters, - foam build-up. <ul style="list-style-type: none"> ■ Identify and resolve the cause of this. ■ The programme was not interrupted, however the wash load must be reprocessed again.

Problem	Cause and remedy
Spray pressure fluctuating too much	<p>The programme was cancelled because the spray arm pressure has deviated by more than 40% from the mean value.</p> <p>Reasons for fluctuations in spray pressure are e.g.:</p> <ul style="list-style-type: none">- defective water connections,- open adapters,- foam build-up. <ul style="list-style-type: none">■ Identify and resolve the cause of this.■ Reprocess the load again.

Problem solving guide

Water inlet and drainage

Problem	Cause and remedy
Check water inlet	One or more stopcocks are closed. ■ Open the stopcocks.
	There was insufficient water in the machine. ■ Clean the water intake filters. ■ Open the stopcocks fully.
	Flow pressure at the water connection is less than 0.3 bar (30 kPa). ■ Contact a suitably qualified plumber.
Check drainage	<p>The water drains away slowly or cannot drain away because ...</p> <ul style="list-style-type: none">... the drain hose is blocked. ■ Remove any kinks or large loops in the drain hose. ■ Start the programme again.- the filters in the wash cabinet are blocked. ■ Clean the filters in the wash cabinet. Protective measures for personal safety must be observed. ■ Start the programme again.- the drain pump or non-return valve may be blocked. ■ Clean the access to drain pumps and the non-return valve. Protective measures for personal safety must be observed. ■ Start the programme again.- the drainage system cannot take sufficient water. ■ Refer to the information in "Plumbing". ■ Contact a suitably qualified plumber.

Noises

Problem	Cause and remedy
Knocking noise in the wash cabinet.	<p>One or more spray arms are knocking against the wash load.</p> <ul style="list-style-type: none"> ■ Cancel the programme. To do this follow the instructions in "Cancelling a programme". ■ Arrange the wash load so it cannot obstruct the spray arms. ■ Make sure the spray arms can rotate freely. ■ Start the programme again.
Rattling noise in the wash cabinet.	<p>Items are insecure in the wash cabinet.</p> <ul style="list-style-type: none"> ■ Cancel the programme. To do this follow the instructions in "Cancelling a programme". ■ Rearrange the load so that items are secure. ■ Start the programme again.
Knocking noise in the water pipes.	<p>This may be caused by the on-site installation or the cross-section of the piping. It has no influence on the function of the machine.</p> <ul style="list-style-type: none"> ■ Contact a suitably qualified plumber.

Problem solving guide

Printer / Serial interface

Problem	Cause and remedy
Serial printer fault: no paper	The printer has run out of paper. ■ Replenish the paper.
Serial printer fault: offline	The washer-disinfector cannot connect to the printer. ■ Switch the printer on. ■ Check the connection between the washer-disinfector and the printer. ■ If in doubt, have the configuration of the interface checked by a suitably qualified person. If the printer has been replaced, the printer type must be adjusted in the interface configuration.
Serial printer fault: general fault	The printer is not ready for operation. ■ Check the printer for fault messages. ■ Change the printer cartridge if necessary.
Network down	The communication module has identified a network interruption or cannot establish a connection. ■ Consult your network administrator. If the problem cannot be resolved: ■ Contact the Miele Service Department.

Cleaning the drain pump and non-return valve

If water has not pumped away at the end of a programme there may be a foreign object in the drain pump or blocking the non-return valve.

- Take the filter combination out of the wash cabinet (see Maintenance / Cleaning the filters in the wash cabinet").

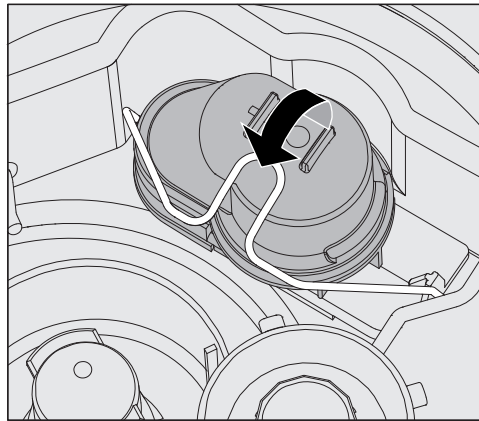

- Lift the locking clamp.
- Lift out the non-return valve and rinse well under running water.
- Make sure that the vent on the external part of the non-return valve is not blocked. (This vent is only visible when the non-return valve has been taken out). If it is blocked, use a pointed object to release the blockage.

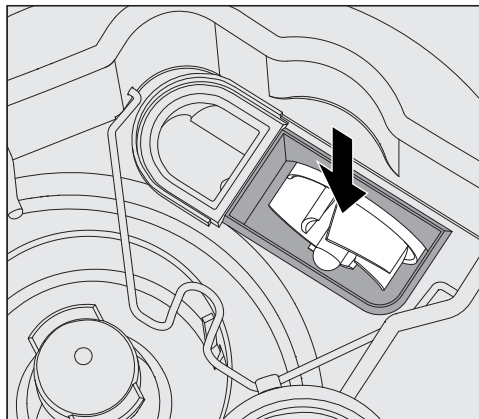

The drain pump impeller is situated under the non-return valve (see arrow).

- Check the impeller for blockages and remove them if necessary.
- Carefully replace the non-return valve and secure it with the clamp.

Remedial maintenance

Clean the water intake filters

Filters are incorporated into the water inlet connection on the hose to protect the water inlet valve. If these filters get dirty they must be cleaned as otherwise too little water will flow into the wash cabinet.

⚠ The plastic housing on the water inlet valve contains an electrical component. It must not be dipped in water.

Cleaning the filters

- Disconnect the machine from the mains (switch the machine off, unplug it or disconnect or disable the fuse).
- Close the stopcock.
- Unscrew the inlet hose.

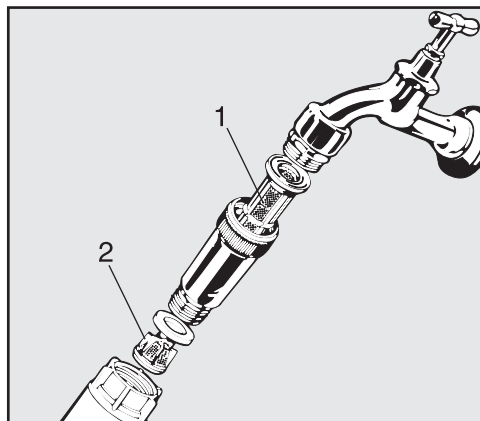

- Carefully pull the large surface area filter 1 out.
- Carefully remove the seal from the threaded union.
- Withdraw fine filter 2 using pointed pliers.
- Clean the filters or replace them with new ones if necessary.
- Replace the filters and seals, making sure they are sitting correctly.
- Reconnect the hose to the stopcock, making sure the union goes on straight and not cross-threaded.
- Turn on the stopcock gradually to test for leaks. If there is a leak, the inlet hose might not be on securely, or it may have been screwed on at an angle. Unscrew and reconnect the water inlet hose correctly before tightening it.

IMPORTANT

Australia and New Zealand

For Australia and New Zealand a non-return valve is required between the tap and filter.

Contacting Miele Service

 Repairs should only be carried out by a suitably qualified and trained Miele technician in accordance with local and national safety regulations. Unauthorised or incorrect repairs could cause personal injury or damage the machine.

To avoid unnecessary service call-outs, check that the fault has not been caused by incorrect operation when an error message first appears. Please refer to the information in "Problem solving guide".

If, having followed the advice in the operating instructions, you are still unable to resolve a problem please call the Miele Service Department (see the end of this booklet for contact details).

Contact details can be found at the end of this manual.

When contacting the Service Department, please quote the model type and number of your machine. These are shown on the data plates one on the side of the door and another on the back of the appliance.

Please tell Miele Service the fault message or code shown in the display.

Software version

When contacting the Service department you may need the version number of individual components of control software. These can be called up as follows:

- Open the menu as follows:

☰ button

- ▶ Further settings
- ▶ Software version



The software units are listed in the display. XXXXX stands for the relevant version number:

- EB Id: XXXXX

Software version of the control and display units in the control panel.

- EGL Id: XXXXX

Software version of the control board

- EZL Id: XXXXX

Software version of the relay board

- EFU Id: XXXXX

Software version of the frequency converter.

You cannot change any settings in this menu.

Software updates and upgrades may only be undertaken by Miele Service.

- Exit the menu with the *OK* or ↶ buttons.

Installation and levelling

Please refer to the installation diagram provided.

⚠ In order to reduce the risk of water damage, the area around the machine should be limited to furniture and fittings that are designed for use in commercial environments.

The machine must be stable and horizontal.

Any unevenness in the floor level can be compensated for by adjusting the two front feet. The feet can be screwed out to a maximum of 8 mm.

With the feet screwed in the machine can be rolled backwards or forwards on fitted castors. To do this the machine must be raised up slightly at the front.

⚠ Do not lift the machine by the control panel or the drawer in the side unit.
This could damage them.

The machine is suitable for the following types of installation:

– Free-standing.

– Slot-in:

The machine can be installed beside other appliances or furniture or in a suitable niche. The niche must be at least 90 cm wide and 60 cm deep.

– Built-under:

The machine can be built under a continuous worktop or the draining board of a sink. The space provided must be at least 90 cm wide, 60 deep and 82 cm high.

Freestanding machines or machines installed in a niche must have the lid fitted.

60 cm or 70 cm deep lids with additional side wall extensions are available from Miele.

Fitting the lid

The lid must be screwed to the washer-disinfector. The side with the screw threads on the underside goes to the front and the side with the safety screw holders protruding downwards goes to the back.

Follow the fitting instructions supplied with the lid.

- Place the lid on the washer-disinfector so that it is flush with the machine.
- Tighten the two securing screws on the back of the machine.
- Open the door.

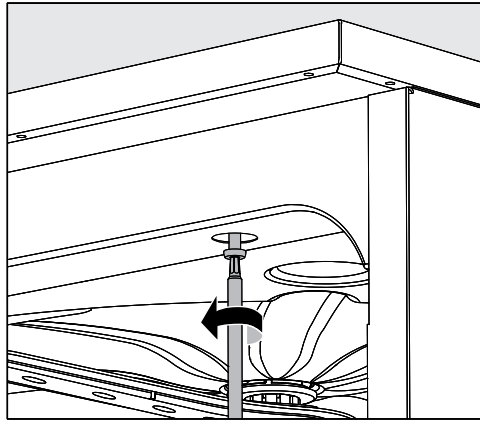

- Remove the cover caps on the left and right and tighten the fixing screws. Then replace the cover caps.

Building under a continuous worktop

Steam condenser

To avoid steam damage to the worktop the protective foil supplied (25 x 58 cm, self-adhesive) must be applied underneath the worktop in the area of the steam condenser.

Protective foil / worktop protector

The protective foil supplied protects the worktop from damage caused by steam when the door is opened. It should be positioned underneath the worktop above the machine door.

Securing to the worktop

To improve stability the machine must be secured to the worktop after it has been aligned.

- Open the door.

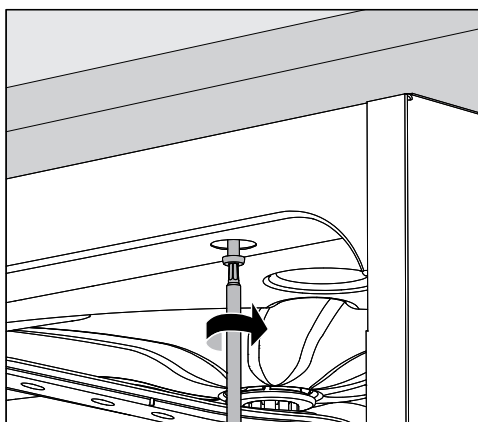

- Screw the machine to the continuous worktop through the holes in the front trim on the left and right.

Please contact Miele to secure it at the sides to adjacent cabinetry.

Venting the circulation pump.

⚠ The gaps between a built-in machine and adjacent cabinetry must not be filled with silicone sealant as this could compromise the ventilation to the circulation pump.

Electromagnetic compatibility (EMC)

The washer-disinfector has been tested for electromagnetic compatibility in accordance with EN 61326-1 and is suitable for operation in commercial environments, such as hospitals, medical practices and laboratories and other similar environments which are connected to the mains power supply.

The washer-disinfector's HF emissions are very low and are therefore unlikely to interfere with other electronic appliances in the vicinity.

Flooring in the installation area must be wood, concrete or tiled. Synthetic flooring must be able withstand a relative humidity level of 30 % to minimise the risk of electrostatic discharges.

The quality of the power supply should comply with that found in a typical commercial or hospital environment and should deviate from the nominal voltage by a maximum of +/- 10 %.

⚠ All electrical work must be carried out by a suitably qualified and competent person in accordance with local and national safety regulations.

- In the U.K. it must comply with BS 7671.
- We recommend connecting the machine to the power supply via a suitable IP 44 plug and socket which must be easily accessible for servicing and maintenance work after the machine has been installed. An electrical safety test must be carried out after installation and after any service work.
- For hard-wired machines, connection should be made via a suitable mains switch with all-pole isolation which when in the off position ensures a 3 mm gap between all open contacts.
- Equipotential bonding should be carried out if required.
- For technical data see data plate or wiring diagram supplied.
- For extra safety and protection we recommend connecting the machine by a 30 mA residual current device (RCD).
- If replacing the mains cable, use only original Miele replacement parts or a suitable cable with core cable ends.

Further notes on electrical connection are given on the Installation diagram supplied with the machine.

The machine must only be operated with the voltage, frequency and fusing shown on the **data plate**.

Depending on country this machine **can be converted to a different type of power supply** in accordance with the conversion diagram and wiring diagram supplied.

A **data plate** can be found on the inside of the door and another on the back of the machine.

The wiring diagram is supplied with the machine.

WARNING

THIS APPLIANCE MUST BE EARTHED

Equipotential bonding connection

There is a screw connection point marked ∇ at the back of the machine, to which additional equipotential bonding can be connected if required.

Connection to the water supply

 Water from the wash cabinet must not be consumed.

- The washer-disinfector must be connected to the water supply in strict accordance with current local and national water authority regulations.
- The water used must at least comply with European regulations for drinking water quality. If the water supply has a high iron content there is a danger of corrosion occurring on items being cleaned in the washer-disinfector, as well as the appliance itself. If the chloride content of the water exceeds 100 mg/l the risk of corrosion to items being cleaned in the washer-disinfector will be further increased.
- In certain regions (e.g. mountainous areas) the water composition may cause precipitates to form, requiring the use of softened water in the steam condenser.
- UK, Australia and New Zealand only: To comply with water regulation requirements, this machine must be connected to the potable water supply via the check valve supplied with the machine.
- The washer-disinfector is supplied as standard for connection to cold water (blue coded hose) and hot water up to max. 65 °C (red coded hose). Connect the inlet hoses to the stopcock valves for cold and hot water.
- If there is no hot water supply available, the inlet hose coded **red** must also be connected to the cold water supply.
- The intake hose without water protection device for the steam condenser is connected to the cold water stopcock.
- The **Minimum flow pressure** for cold water is 100 kPa pressure, for hot water 40 kPa pressure and for AD water connection is 30 kPa pressure.
- **Recommended flow pressure** for cold and hot water connections is ≥ 200 kPa pressure and for AD water connection ≥ 200 kPa pressure, to avoid excessively long water intake times.
- The **maximum permissible static water pressure** is 1000 kPa pressure.
- If the water pressure does not fall into the stated range contact Miele Service for advice.
- More information on AD water connection can be found at the end of this section.
- A stopcock valve with a $\frac{3}{4}$ " threaded union must be provided on site. It should be easily accessible so that the water supply can be turned off when the machine is not in use.
- The inlet hose is approx. 1.7 m long terminating in a $\frac{3}{4}$ " female thread. On no account may the inlet filter be removed.

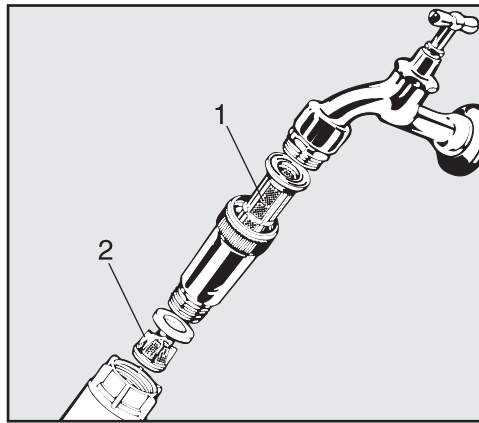

- Install the filter (supplied in accessory pack) between the stopcock valve and the inlet hose. The filter for AD water is made of chromium-nickel steel and can be recognised by its dull surface.

IMPORTANT

Australia and New Zealand

For Australia and New Zealand a non-return valve is required between the tap and filter.

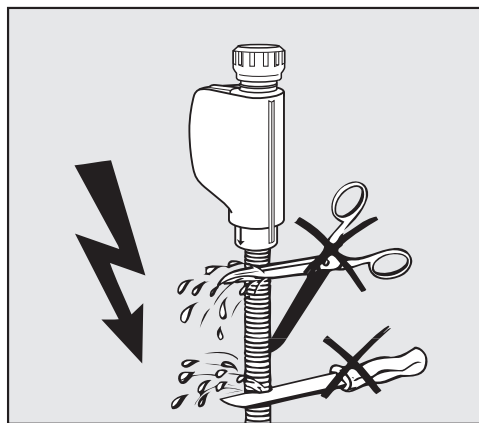

⚠ Do **NOT** shorten or otherwise damage the inlet hoses (see diagram).

See installation diagram supplied.

Plumbing

AD water connection for 30 - 1000 kPa pressure - pressure-resistant (optional)

This machine can be optionally supplied for a pressurised system operating between 30 - 1000 kPa. If the water pressure is below 200 kPa the water intake duration will be automatically increased.

- The pressure tested hose for AD water, coded green, has a 3/4 inch threaded union for connection to the onsite stopcock for AD water.

⚠ If the machine is not going to be connected to AD water, the AD water connection has to be deactivated by a Miele Service technician. The inlet hose remains in position at the back of the machine.

AD water connection for 8.5 - 60 kPa - without pressure (optional)

The machine has to be converted for connection to 8.5 - 60 kPa pressure unless ordered as such ex-works. Installation of the pump must only be carried out by Miele Service.

With a pressureless AD water connection, the drainage point must be at least as high as the top of the machine. See installation instructions.

IMPORTANT

Australia and New Zealand.

This appliance must be installed according to AS/NZS 3500.1. This appliance has been supplied with a separate backflow prevention device.

This machine must be connected to the potable water supply via the non-return valve (check valve) supplied with the machine.

Before making plumbing connections, ensure the appliance is disconnected from the mains power supply (switch off or unplug the power).

- Turn off the mains water tap.
- Place the seals on both sides of the non-return valve.
- Connect the female end of the non-return valve to the mains water tap (3/4" thread).
- Connect the filter to the male end of the non-return valve (3/4" thread).
- Connect the inlet hose to the filter.

Ensure that all connections are screwed into position correctly. The connection point is subject to mains water pressure. Turn on the tap slowly and check for leaks. Correct the position of the seal and union if necessary.

Connecting the drain hose

- A non-return valve is incorporated into the drain system in the machine to prevent drainage water flowing back into the machine via the drain hose.
- The machine drainage hose should be connected to a **separate** drain for the machine only. If no separate drain is available, we recommend connecting it to a dual-chamber siphon.
- The on-site connection point, **measured from the lower edge of the machine**, should be positioned at a height between 0.3 m and 1 m. If it is lower than 0.3 m, the drain hose must be laid in a coil at a height of at least 0.3 m.
- The drainage system must be able to accommodate a minimum drainage flow of 16 l/min.
- The drainage hose is approx. 1.4 m long and flexible with an internal diameter of 22 mm. Hose clips for the connection are supplied.
- The drain hose must not be shortened.
- The drain hose can be extended using a connection piece to attach a further length of hose up to 4 m long. The drainage length must not exceed 4 m.
- Drainage noise can be considerably reduced if the drainage hose is positioned in an arc at a minimum height of 0.6 m and a max. height of 1 m measured from the bottom edge of the washer-disinfector.

See installation diagram supplied.

Programme chart

Free memory

New programme name:

Application:

Programmable programme for special applications.
Please contact Miele Service to have the programme set up.

Programme header

- ▶ Change volume of water [l] _____ Spray arm monitoring
- Drain time ▶ On
- ▶ Standard ▶ Off for basket
- ▶ Increased ▶ Off

Parameters		Wash block	Pre-wash		
			1	2	3
Water quality					
Dosage	1	Dispensing system			
		▶ Concentration [%]			
	2	Dispensing system			
		▶ Concentration [%]			
▶ Wash block temperature					
▶ Holding time [Min]					
▶ Monitor LFMMc (conductivity)					

Drying unit

- Cooling down pause ▶ Temperature 2 _____
- ▶ No
- ▶ Set [seconds] _____
- ▶ Temperature 1 _____
- ▶ Drying time 1 [Min] _____
- ▶ Temperature 2 _____
- Drying time 2
- ▶ Set [Min] _____
- ▶ Time changeable? Yes / No
- Cooling down with fan
- ▶ No
- ▶ Set [Min] _____

<p>LFMMc max. value (optional)</p> <table style="width: 100%; border: none;"> <tr> <td style="width: 50%; border: none;"> <p>Water intake</p> <p>▶ Set [μS/cm] _____</p> <p>▶ Number of repeats <input type="checkbox"/> 0 / <input type="checkbox"/> 1</p> </td> <td style="width: 50%; border: none;"> <p>Water drainage</p> <p>▶ Set [μS/cm] _____</p> <p>▶ Number of repeats <input type="checkbox"/> 0 / <input type="checkbox"/> 1</p> </td> </tr> </table>	<p>Water intake</p> <p>▶ Set [μS/cm] _____</p> <p>▶ Number of repeats <input type="checkbox"/> 0 / <input type="checkbox"/> 1</p>	<p>Water drainage</p> <p>▶ Set [μS/cm] _____</p> <p>▶ Number of repeats <input type="checkbox"/> 0 / <input type="checkbox"/> 1</p>
<p>Water intake</p> <p>▶ Set [μS/cm] _____</p> <p>▶ Number of repeats <input type="checkbox"/> 0 / <input type="checkbox"/> 1</p>	<p>Water drainage</p> <p>▶ Set [μS/cm] _____</p> <p>▶ Number of repeats <input type="checkbox"/> 0 / <input type="checkbox"/> 1</p>	

Cleaning		Interim rinse				Final rinse	
1	2	1	2	3	4	1	2

▶ = Customisable parameters

CW = cold water

HW = hot water

CWxx = CW proportion in mixed water as percentage (CW70 = 70 % CW + 30 % HW)

AD = aqua destillata, fully demineralised water (VE), demineralised water

Min = Holding time in minutes

DOS 1 = Cleaning agent

DOS 3 = Neutralising agent

DOS 4 = DOS module

Programme chart

Free memory

New programme name:

Application:

Programmable programme for special applications.

Please contact Miele Service to have the programme set up.

Programme header

▶ Change volume of water [l] _____ Spray arm monitoring

Drain time

▶ On

▶ Standard

▶ Off for basket

▶ Increased

▶ Off

Parameters		Wash block	Pre-wash		
			1	2	3
Water quality					
Dosage	1	Dispensing system			
		▶ Concentration [%]			
	2	Dispensing system			
		▶ Concentration [%]			
▶ Wash block temperature					
▶ Holding time [Min]					
▶ Monitor LFMMc (conductivity)					

Drying unit

Cooling down pause

▶ Temperature 2 _____

▶ No

Drying time 2 _____

▶ Set [seconds] _____

▶ Set [Min] _____

▶ Temperature 1 _____

▶ Time changeable? Yes / No

▶ Drying time 1 [Min] _____

Cooling down with fan

▶ No

▶ Set [Min] _____

LFMMc max. value (optional)	
Water intake	Water drainage
▶ Set [μ S/cm] _____	▶ Set [μ S/cm] _____
▶ Number of repeats <input type="checkbox"/> 0 / <input type="checkbox"/> 1	▶ Number of repeats <input type="checkbox"/> 0 / <input type="checkbox"/> 1

Cleaning		Interim rinse				Final rinse	
1	2	1	2	3	4	1	2

▶ = Customisable parameters

CW = cold water
 HW = hot water
 CWxx = CW proportion in mixed water as percentage (CW70 = 70 % CW + 30 % HW)
 AD = aqua destillata, fully demineralised water (VE), demineralised water

Min = Holding time in minutes

DOS 1 = Cleaning agent
 DOS 3 = Neutralising agent
 DOS 4 = DOS module

Programme chart

Universal

Application:

For removing organic residues and certain inorganic residues

Programme header

- ▶ Change volume of water [l] _____ Spray arm monitoring
- Drain time ▶ On
- ▶ Standard ▶ Off for basket
- ▶ Increased ▶ Off

Parameters		Wash block	Pre-wash		
			1	2	3
Water quality			CW50		
Dosage	1	Dispensing system			
		▶ Concentration [%]			
	2	Dispensing system			
		▶ Concentration [%]			
▶ Wash block temperature					
▶ Holding time [Min]			1		
▶ Monitor LFMMc (conductivity)					

Drying unit

- Cooling down pause ▶ Temperature 2 110 °C
- ▶ No
- ▶ Set [seconds] 30
- ▶ Temperature 1 _____
- ▶ Drying time 1 [Min] _____
- ▶ Temperature 2 110 °C
- Drying time 2
- ▶ Set [Min] 30
- ▶ Time changeable? Yes / No
- Cooling down with fan
- ▶ No
- ▶ Set [Min] 2

- For preparative and analytical applications,
- for light to medium levels of soiling,
- for normal wash result requirements.

LFMMc max. value (optional)

Water intake

▶ Set [μ S/cm]

▶ Number of repeats 0 / 1

Water drainage

▶ Set [μ S/cm]

▶ Number of repeats 0 / 1

Cleaning		Interim rinse				Final rinse	
1	2	1	2	3	4	1	2
HW		HW	HW	AD		AD	
DOS 1		DOS 3					
0.3		0.1					
75 °C						75 °C	
3		2	1	1		1	
						On	

* Organic residues such as oils and fats require conversion to oil-resistant elastomers if necessary.

▶ = Customisable parameters

CW = cold water

HW = hot water

CWxx = CW proportion in mixed water as percentage (CW70 = 70 % CW + 30 % HW)

AD = aqua destillata, fully demineralised water (VE), demineralised water

Min = Holding time in minutes

DOS 1 = Cleaning agent

DOS 3 = Neutralising agent

DOS 4 = DOS module

Programme chart

Standard

Application:

Simple programme for a range of soiling.

Not suitable for denatured and acid soluble residues such as protein, metallic salts and amines.

Programme header

▶ Change volume of water [l] _____ Spray arm monitoring

Drain time

▶ On

▶ Standard

▶ Off for basket

▶ Increased

▶ Off

Parameters		Wash block	Pre-wash		
			1	2	3
Water quality					
Dosage	1	Dispensing system			
		▶ Concentration [%]			
2		Dispensing system			
		▶ Concentration [%]			
▶ Wash block temperature					
▶ Holding time [Min]					
▶ Monitor LFMMc (conductivity)					

Drying unit

Cooling down pause

▶ Temperature 2

110 °C

▶ No

Drying time 2

▶ Set [seconds]

30

▶ Set [Min]

30

▶ Temperature 1

▶ Time changeable?

Yes / No

▶ Drying time 1 [Min]

Cooling down with fan

▶ No

▶ Set [Min]

2

- For light soiling,
- for low wash result requirements.

LFMMc max. value (optional)

Water intake

▶ Set [μ S/cm]

▶ Number of repeats 0 / 1

Water drainage

▶ Set [μ S/cm]

▶ Number of repeats 0 / 1

Cleaning		Interim rinse				Final rinse	
1	2	1	2	3	4	1	2
CW50		HW	AD			AD	
DOS 1		DOS 3					
0.4		0.1					
70 °C						70 °C	
3		2	1			1	
						On	

▶ = Customisable parameters

CW = cold water

HW = hot water

CWxx = CW proportion in mixed water as percentage (CW70 = 70 % CW + 30 % HW)

AD = aqua destillata, fully demineralised water (VE), demineralised water

Min = Holding time in minutes

DOS 1 = Cleaning agent

DOS 3 = Neutralising agent

DOS 4 = DOS module

Programme chart

Intensive

Application:

For removing organic residues and certain inorganic residues

Programme header

- ▶ Change volume of water [l] _____ Spray arm monitoring
- Drain time ▶ On
- ▶ Standard ▶ Off for basket
- ▶ Increased ▶ Off

Parameters		Wash block	Pre-wash		
			1	2	3
Water quality			CW50		
Dosage	1	Dispensing system			
		▶ Concentration [%]			
	2	Dispensing system			
		▶ Concentration [%]			
▶ Wash block temperature					
▶ Holding time [Min]			1		
▶ Monitor LFMMc (conductivity)					

Drying unit

- Cooling down pause ▶ Temperature 2 110 °C
- ▶ No
- ▶ Set [seconds] 30
- ▶ Temperature 1 _____
- ▶ Drying time 1 [Min] _____
- ▶ Temperature 2 110 °C
- Drying time 2
- ▶ Set [Min] 30
- ▶ Time changeable? Yes / No
- Cooling down with fan
- ▶ No
- ▶ Set [Min] 2

- For preparative and analytical applications,
- for normal to heavy soiling,
- for normal to high wash result requirements.

LFMMc max. value (optional)

Water intake

▶ Set [μ S/cm]

▶ Number of repeats 0 / 1

Water drainage

▶ Set [μ S/cm]

▶ Number of repeats 0 / 1

Cleaning		Interim rinse				Final rinse	
1	2	1	2	3	4	1	2
HW		HW	AD	AD		AD	
DOS 1		DOS 3					
0.4		0.1					
80 °C						75 °C	
3		2	1	1		1	
						On	

* Organic residues such as oils and fats require conversion to oil-resistant elastomers if necessary.

▶ = Customisable parameters

CW = cold water

HW = hot water

CWxx = CW proportion in mixed water as percentage (CW70 = 70 % CW + 30 % HW)

AD = aqua destillata, fully demineralised water (VE), demineralised water

Min = Holding time in minutes

DOS 1 = Cleaning agent

DOS 3 = Neutralising agent

DOS 4 = DOS module

Programme chart

Inorganic

Application:
Removal of inorganic residue

Programme header

▶ Change volume of water [l] _____	Spray arm monitoring
Drain time	▶ <input checked="" type="checkbox"/> On
▶ <input checked="" type="checkbox"/> Standard	▶ <input type="checkbox"/> Off for basket
▶ <input type="checkbox"/> Increased	▶ <input type="checkbox"/> Off

Parameters		Wash block	Pre-wash		
			1	2	3
Water quality					
Dosage	1	Dispensing system			
		▶ Concentration [%]			
2		Dispensing system			
		▶ Concentration [%]			
▶ Wash block temperature					
▶ Holding time [Min]					
▶ Monitor LFMMc (conductivity)					

Drying unit

Cooling down pause		▶ Temperature 2	110 °C
▶ <input type="checkbox"/> No		Drying time 2	
▶ Set [seconds]	30	▶ Set [Min]	30
▶ Temperature 1	_____	▶ Time changeable?	<input type="checkbox"/> Yes / <input checked="" type="checkbox"/> No
▶ Drying time 1 [Min]	_____	Cooling down with fan	
		▶ <input type="checkbox"/> No	
		▶ Set [Min]	2

- General programme for analysis and water analysis and for water based cultures with acid-soluble metallic salts such as Ca^{2+} and Mg^{2+} etc.,
- for light to medium levels of soiling,
- for normal to high wash result requirements.

LFMMc max. value (optional)

Water intake

▶ Set [$\mu\text{S}/\text{cm}$]

▶ Number of repeats 0 / 1

Water drainage

▶ Set [$\mu\text{S}/\text{cm}$]

▶ Number of repeats 0 / 1

Cleaning		Interim rinse				Final rinse	
1	2	1	2	3	4	1	2
CW50	HW	HW	AD	AD		AD	
DOS 3	DOS 1	DOS 3					
0.3	0.4	0.1					
50 °C	75 °C					70 °C	
2	3	2	1	1		1	
						On	

▶ = Customisable parameters

CW = cold water

HW = hot water

CWxx = CW proportion in mixed water as percentage (CW70 = 70 % CW + 30 % HW)

AD = aqua destillata, fully demineralised water (VE), demineralised water

Min = Holding time in minutes

DOS 1 = Cleaning agent

DOS 3 = Neutralising agent

DOS 4 = DOS module

Programme chart

Organica

Application:

For removing concentrated organic residues* such as oils, fats, waxes etc.
 Not suitable for acid-soluble residues e.g. metallic salt, amine etc.

Programme header

- ▶ Change volume of water [l] _____ Spray arm monitoring
- Drain time ▶ On
- ▶ Standard ▶ Off for basket
- ▶ Increased ▶ Off

Parameters		Wash block	Pre-wash		
			1	2	3
Water quality					
Dosage	1	Dispensing system			
		▶ Concentration [%]			
	2	Dispensing system			
		▶ Concentration [%]			
▶ Wash block temperature					
▶ Holding time [Min]					
▶ Monitor LFMMc (conductivity)					

Drying unit

- Cooling down pause ▶ Temperature 2 110 °C
- ▶ No
- ▶ Set [seconds] 30
- ▶ Temperature 1 _____
- ▶ Drying time 1 [Min] _____
- ▶ Temperature 2 110 °C
- Drying time 2
- ▶ Set [Min] 30
- ▶ Time changeable? Yes / No
- Cooling down with fan
- ▶ No
- ▶ Set [Min] 2

- For normal to heavy soiling,
- for normal to high wash result requirements.

Use liquid cleaning agent, hot and AD water connection recommended.

LFMMc max. value (optional)

Water intake

▶ Set [μ S/cm]

▶ Number of repeats 0 / 1

Water drainage

▶ Set [μ S/cm]

▶ Number of repeats 0 / 1

Cleaning		Interim rinse				Final rinse	
1	2	1	2	3	4	1	2
HW	HW	HW	HW	AD		AD	
DOS 1	DOS 1	DOS 3					
0.4	0.3	0.1					
65 °C	85 °C					75 °C	
3	3	2	1	1		1	
						On	

* Organic residues such as oils and fats require conversion to oil-resistant elastomers if necessary.

▶ = Customisable parameters

CW = cold water

HW = hot water

CWxx = CW proportion in mixed water as percentage (CW70 = 70 % CW + 30 % HW)

AD = aqua destillata, fully demineralised water (VE), demineralised water

Min = Holding time in minutes

DOS 1 = Cleaning agent

DOS 3 = Neutralising agent

DOS 4 = DOS module

Programme chart

Injector Plus

Application:

Programme with increased water pressure and increased water levels for the following basket combinations:

- Upper basket with one spray arm and lower basket with 2 injector modules.
- Upper and lower baskets with a total of 4 injector modules.

Programme header

- ▶ Change volume of water [l] _____ Spray arm monitoring
- Drain time ▶ On
- ▶ Standard ▶ Off for basket
- ▶ Increased ▶ Off

Parameters		Wash block	Pre-wash		
			1	2	3
Water quality			CW50		
Dosage	1	Dispensing system			
		▶ Concentration [%]			
	2	Dispensing system			
		▶ Concentration [%]			
▶ Wash block temperature					
▶ Holding time [Min]			1		
▶ Monitor LFMMc (conductivity)					

Drying unit

- Cooling down pause ▶ Temperature 2 _____ 110 °C
- ▶ No
- ▶ Set [seconds] _____ 30
- ▶ Temperature 1 _____
- ▶ Drying time 1 [Min] _____
- ▶ Temperature 2 _____ 110 °C
- Drying time 2
- ▶ Set [Min] _____ 30
- ▶ Time changeable? Yes / No
- Cooling down with fan
- ▶ No
- ▶ Set [Min] _____ 2

Programme chart

Use as described for the Universal programme

LFMMc max. value (optional)

Water intake

▶ Set [μ S/cm]

▶ Number of repeats 0 / 1

Water drainage

▶ Set [μ S/cm]

▶ Number of repeats 0 / 1

Cleaning		Interim rinse				Final rinse	
1	2	1	2	3	4	1	2
HW		HW	HW	AD		AD	
DOS 1		DOS 3					
0.3		0.1					
75 °C						75 °C	
3		2	1	1		1	
						On	

▶ = Customisable parameters

CW = cold water

HW = hot water

CWxx = CW proportion in mixed water as percentage (CW70 = 70 % CW + 30 % HW)

AD = aqua destillata, fully demineralised water (VE), demineralised water

Min = Holding time in minutes

DOS 1 = Cleaning agent

DOS 3 = Neutralising agent

DOS 4 = DOS module

Programme chart

Pipettes

Application:
For pipettes

Programme header	
▶ Change volume of water [l] _____	Spray arm monitoring
Drain time	▶ <input checked="" type="checkbox"/> On
▶ <input checked="" type="checkbox"/> Standard	▶ <input type="checkbox"/> Off for basket
▶ <input type="checkbox"/> Increased	▶ <input type="checkbox"/> Off

Parameters		Wash block	Pre-wash		
			1	2	3
Water quality			CW50		
Dosage	1	Dispensing system			
		▶ Concentration [%]			
	2	Dispensing system			
		▶ Concentration [%]			
▶ Wash block temperature					
▶ Holding time [Min]			1		
▶ Monitor LFMMc (conductivity)					

Drying unit			
Cooling down pause		▶ Temperature 2	80 °C
▶ <input type="checkbox"/> No		Drying time 2	
▶ Set [seconds]	30	▶ Set [Min]	35
▶ Temperature 1	_____	▶ Time changeable?	<input type="checkbox"/> Yes / <input checked="" type="checkbox"/> No
▶ Drying time 1 [Min]	_____	Cooling down with fan	
		▶ <input type="checkbox"/> No	
		▶ Set [Min]	2

LFMMc max. value (optional)

Water intake

▶ Set [μ S/cm]

▶ Number of repeats 0 / 1

Water drainage

▶ Set [μ S/cm]

▶ Number of repeats 0 / 1

Cleaning		Interim rinse				Final rinse	
1	2	1	2	3	4	1	2
HW		HW	AD	AD		AD	
DOS 1		DOS 3					
0.4		0.1					
70 °C						70 °C	
3		2	1	1		1	
						On	

▶ = Customisable parameters

CW = cold water

HW = hot water

CWxx = CW proportion in mixed water as percentage (CW70 = 70 % CW + 30 % HW)

AD = aqua destillata, fully demineralised water (VE), demineralised water

Min = Holding time in minutes

DOS 1 = Cleaning agent

DOS 3 = Neutralising agent

DOS 4 = DOS module

Programme chart

Plastics

Application:

For heat-sensitive loads, such as plastic flasks (**temperature resistance: at least 55 °C**).

Programme header

- ▶ Change volume of water [l] _____ Spray arm monitoring
- Drain time ▶ On
- ▶ Standard ▶ Off for basket
- ▶ Increased ▶ Off

Parameters		Wash block	Pre-wash		
			1	2	3
Water quality			CW		
Dosage	1	Dispensing system			
		▶ Concentration [%]			
	2	Dispensing system			
		▶ Concentration [%]			
▶ Wash block temperature					
▶ Holding time [Min]			1		
▶ Monitor LFMMc (conductivity)					

Drying unit

- Cooling down pause ▶ Temperature 2 _____ 70 °C
- ▶ No Drying time 2
- ▶ Set [seconds] _____ 15
- ▶ Temperature 1 _____ 80 °C ▶ Time changeable? Yes / No
- ▶ Drying time 1 [Min] _____ 30
- Cooling down with fan
- ▶ No
- ▶ Set [Min] _____ 2

- For preparative and analytical applications,
- for light to medium levels of soiling,
- for normal wash result requirements.

LFMMc max. value (optional)

Water intake

▶ Set [μ S/cm]

▶ Number of repeats 0 / 1

Water drainage

▶ Set [μ S/cm]

▶ Number of repeats 0 / 1

Cleaning		Interim rinse				Final rinse	
1	2	1	2	3	4	1	2
CW		CW	CW	AD		AD	
DOS 1		DOS 3					
0.3		0.1					
55 °C						55 °C	
3		2	1	1		1	
						On	

▶ = Customisable parameters

CW = cold water

HW = hot water

CWxx = CW proportion in mixed water as percentage (CW70 = 70 % CW + 30 % HW)

AD = aqua destillata, fully demineralised water (VE), demineralised water

Min = Holding time in minutes

DOS 1 = Cleaning agent

DOS 3 = Neutralising agent

DOS 4 = DOS module

Programme chart

Mini

Application:

Short programme for lightly soiled items and loads that do not require intensive cleaning.

Programme header

- ▶ Change volume of water [l] _____ Spray arm monitoring
- Drain time
 - ▶ On
 - ▶ Off for basket
- ▶ Standard
- ▶ Increased
- ▶ Off

Parameters		Wash block	Pre-wash		
			1	2	3
Water quality					
Dosage	1	Dispensing system			
		▶ Concentration [%]			
2		Dispensing system			
		▶ Concentration [%]			
▶ Wash block temperature					
▶ Holding time [Min]					
▶ Monitor LFMMc (conductivity)					

Drying unit

- Cooling down pause
 - ▶ No
 - ▶ Set [seconds] _____
- ▶ Temperature 1 _____
- ▶ Drying time 1 [Min] _____
- ▶ Temperature 2 _____ 110 °C
- Drying time 2
 - ▶ Set [Min] _____ 30
 - ▶ Time changeable? Yes / No
- Cooling down with fan
 - ▶ No
 - ▶ Set [Min] _____ 2

LFMMc max. value (optional)

Water intake

▶ Set [μ S/cm]

▶ Number of repeats 0 / 1

Water drainage

▶ Set [μ S/cm]

▶ Number of repeats 0 / 1

Cleaning		Interim rinse				Final rinse	
1	2	1	2	3	4	1	2
HW		HW				AD	
DOS 1		DOS 3					
0.3		0.1					
60 °C						60 °C	
3		2				1	
						On	

▶ = Customisable parameters

CW = cold water

HW = hot water

CWxx = CW proportion in mixed water as percentage (CW70 = 70 % CW + 30 % HW)

AD = aqua destillata, fully demineralised water (VE), demineralised water

Min = Holding time in minutes

DOS 1 = Cleaning agent

DOS 3 = Neutralising agent

DOS 4 = DOS module

Programme chart

Oil programme

Application:

For heavy oil soiling such as crude oil, synthetic oils/lubricants, fuels and partially natural oils.

The machine should be refitted with oil resistant elastomers where soiling contains high levels of oil.

Programme header

- ▶ Change volume of water [l] _____ Spray arm monitoring
- Drain time
 - ▶ On
 - ▶ Off for basket
- ▶ Standard
 - ▶ Off
- ▶ Increased

Parameters		Wash block	Pre-wash		
			1	2	3
Water quality			HW		
Dosage	1	Dispensing system	DOS 4		
		▶ Concentration [%]	0.5		
	2	Dispensing system	DOS 1		
		▶ Concentration [%]	0.3		
▶ Wash block temperature			45 °C		
▶ Holding time [Min]			1		
▶ Monitor LFMMc (conductivity)					

Drying unit

- Cooling down pause
 - ▶ No
 - ▶ Temperature 2 _____ 110 °C
 - ▶ Set [seconds] _____ 30
 - ▶ Drying time 2 _____
 - ▶ Set [Min] _____ 30
 - ▶ Temperature 1 _____
 - ▶ Time changeable? Yes / No
 - ▶ Drying time 1 [Min] _____
 - Cooling down with fan
 - ▶ No
 - ▶ Set [Min] _____ 2

Use liquid cleaning agent, hot and AD water connection recommended.

LFMMc max. value (optional)

Water intake

▶ Set [μ S/cm]

▶ Number of repeats 0 / 1

Water drainage

▶ Set [μ S/cm]

▶ Number of repeats 0 / 1

Cleaning		Interim rinse				Final rinse	
1	2	1	2	3	4	1	2
HW	HW	HW	HW	AD		AD	
DOS 4	DOS 1	DOS 3					
0.4	0.3	0.1					
DOS 1							
0.4							
65 °C	85 °C					75 °C	
2	3	2	1	1		1	
						On	

▶ = Customisable parameters

CW = cold water

HW = hot water

CWxx = CW proportion in mixed water as percentage (CW70 = 70 % CW + 30 % HW)

AD = aqua destillata, fully demineralised water (VE), demineralised water

Min = Holding time in minutes

DOS 1 = Cleaning agent

DOS 3 = Neutralising agent

DOS 4 = DOS module

Programme chart

Special 93°C-10'

Application:

For cleaning and thermal disinfection at 93 °C with 10 minutes temperature holding time (exposure time).

Programme header

- ▶ Change volume of water [l] _____ Spray arm monitoring
- Drain time
 - ▶ On
 - ▶ Off for basket
- ▶ Standard
 - ▶ Off
- ▶ Increased

Parameters		Wash block	Pre-wash		
			1	2	3
Water quality					
Dosage	1	Dispensing system			
		▶ Concentration [%]			
2		Dispensing system			
		▶ Concentration [%]			
▶ Wash block temperature					
▶ Holding time [Min]					
▶ Monitor LFMMc (conductivity)					

Drying unit

- Cooling down pause
 - ▶ No
 - ▶ Temperature 2 _____ 95 °C
- ▶ Set [seconds] _____ 30
 - Drying time 2
 - ▶ Set [Min] _____ 50
- ▶ Temperature 1 _____ 100 °C
 - ▶ Time changeable? Yes / No
- ▶ Drying time 1 [Min] _____ 20
 - Cooling down with fan
 - ▶ No
 - ▶ Set [Min] _____ 2

Programme chart

LFMMc max. value (optional)

Water intake

▶ Set [μ S/cm]

▶ Number of repeats 0 / 1

Water drainage

▶ Set [μ S/cm]

▶ Number of repeats 0 / 1

Cleaning		Interim rinse				Final rinse	
1	2	1	2	3	4	1	2
CW70		HW	HW			AD	
DOS 1		DOS 3					
0.6		0.1					
93 °C						75 °C	
10		1	1			3	
						On	

▶ = Customisable parameters

CW = cold water

HW = hot water

CWxx = CW proportion in mixed water as percentage (CW70 = 70 % CW + 30 % HW)

AD = aqua destillata, fully demineralised water (VE), demineralised water

Min = Holding time in minutes

DOS 1 = Cleaning agent

DOS 3 = Neutralising agent

DOS 4 = DOS module

Programme chart

Demin. rinse

Application:

Rinse with demineralised water (fully demineralised water, pure water, demineralised water), holding time: 3 Min.

Rinse

Application:

Cold water rinse, holding time: 1 Min. For flushing out saline solution (see "Water softener"), rinsing heavily soiled loads, e.g for pre-rinsing soiling, residual disinfecting agent, or to prevent items drying out and to prevent incrustation before running a full load.

Drain

Application:

For draining wash water e.g. after a programme cancellation (see Operation/ Cancelling a programme").

Technical data

Height with machine lid	83.5 cm
Height without machine lid	82 cm
Width	90 cm
Depth	60 cm
Depth with door open	120 cm
Wash cavity dimensions height / width / depth	52.2 / 53.6 / 51.8 upper basket and 52.3 cm lower basket
Weight (net)	98 kg
Max. load capacity of open door	37 kg
Voltage, connected load, fuse rating	See data plate
Mains cable	Approx. 1.8 m
Water temperature water connection: Cold water / Steam condenser Hot water / AD water (optional)	max. 20 °C max. 65 °C
Static water pressure	Max. 1000 kPa pressure
Minimum water connection flow pressure: Cold water / steam condenser Hot water AD water (optional)	100 kPa pressure 40 kPa pressure 30 kPa pressure
Recommended water connection flow pressure: Cold water / hot water AD water (optional) Steam condenser	≥ 200 kPa pressure ≥ 200 kPa pressure ≥ 100 kPa pressure
AD water connection without pressure (optional)	8.5 - 60 kPa
Delivery head	min. 0.3 m, max. 1 m
Drainage length	max. 4 m
Ambient temperature	5 °C to 40 °C
Relative humidity maximum linear decreasing to	80 % for temperatures up to 31 °C 50 % for temperatures up to 40 °C
Altitude above sea level	Up to 1500 m*
Protection category (according to IEC 60529)	IP21
Soiling level (according to IEC/EN 61010-1)	2
Overvoltage category (according to IEC 60664)	II
Noise level in dB (A), sound pressure LpA during cleaning and drying phases	< 70
Test certificates awarded	EMC, VDE, radio and television suppressed
C€ mark	2006/42/EC Machine guidelines
Manufacturer's address	Miele & Cie. KG, Carl-Miele-Straße 29, 33332 Gütersloh, Germany

* If installed above 1500 m the boiling point of water will be lower. In this case the disinfecting temperature and the holding time will need to be reset.

Caring for the environment

Disposal of the packing material

The packaging is designed to protect the machine against transportation damage. The packaging materials used are selected from materials which are environmentally friendly for disposal and should be recycled.

Recycling the packaging reduces the use of raw materials in the manufacturing process and also reduces the amount of waste in landfill sites.

Disposing of your old machine

Electrical and electronic machines often contain valuable materials. They also contain materials which, if handled or disposed of incorrectly, could be potentially hazardous to human health and to the environment. They are, however, essential for the correct functioning of your machine. Please do not therefore dispose of it with your household waste.

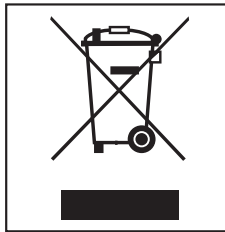

Please dispose of it at your local community waste collection / recycling centre or contact your dealer for advice.

Ensure that it presents no danger to children while being stored for disposal.

United Kingdom

Miele Co. Ltd.
Fairacres, Marcham Road
Abingdon, Oxon, OX14 1TW
Professional Sales, Tel: 0845 365 6608
E-mail: professional@miele.co.uk
Internet: www.miele-professional.co.uk

Australia

Miele Australia Pty. Ltd.
ACN 005 635 398
ABN 96 005 635 398
1 Gilbert Park Drive, Knoxfield, VIC 3180
Tel: 1300 731 411
Internet: www.miele-professional.com.au
E-mail: info@miele-professional.com.au

China

Miele (Shanghai) Trading Ltd.
1-3 Floor, No. 82 Shi Men Yi Road
Jing' an District
200040 Shanghai, PRC
Tel: +86 21 6157 3500, Fax: +86 21 6157 3511
E-mail: info@miele.cn, Internet: www.miele.cn

Miele (Hong Kong) Limited

41/F - 4101, Manhattan Place
23 Wang Tai Road
Kowloon Bay, Hong Kong
Tel: (852) 2610 1331, Fax: (852) 2610 1013
Email: mielehk@miele.com.hk

India

Miele India Pvt. Ltd.
Ground Floor, Copia Corporate Suites
Plot No. 9, Jasola
New Delhi - 110025
Tel: 011-46 900 000, Fax: 011-46 900 001
E-mail: customercare@miele.in, Internet: www.miele.in

Ireland

Miele Ireland Ltd.
2024 Bianconi Avenue
Citywest Business Campus, Dublin 24
Tel: (01) 461 07 10, Fax: (01) 461 07 97
E-Mail: info@miele.ie, Internet: www.miele.ie

Manufacturer: Miele & Cie. KG
Carl-Miele-Straße 29, 33332 Gütersloh, Germany

Miele

PROFESSIONAL

Malaysia

Miele Sdn Bhd
Suite 12-2, Level 12
Menara Sapura Kencana Petroleum
Solaris Dutamas No. 1, Jalan Dutamas 1
50480 Kuala Lumpur, Malaysia
Phone: +603-6209-0288
Fax: +603-6205-3768

New Zealand

Miele New Zealand Limited
IRD 98 463 631
Level 2, 10 College Hill
Freemans Bay, Auckland 1011, NZ
Tel: 0800 464 353
Internet: www.miele-professional.com.au
E-mail: info@miele-professional.com.au

Singapore

Miele Pte. Ltd.
163 Penang Road
04 - 03 Winsland House II
Singapore 238463
Tel: +65 6735 1191, Fax: +65 6735 1161
E-Mail: info@miele.com.sg
Internet: www.miele.sg

South Africa

Miele (Pty) Ltd
63 Peter Place, Bryanston 2194
P.O. Box 69434, Bryanston 2021
Tel: (011) 875 9000, Fax: (011) 875 9035
E-mail: info@miele.co.za
Internet: www.miele.co.za

United Arab Emirates

Miele Appliances Ltd.
P.O. Box 11 47 82
Gold & Diamond Park, Sheikh Zayed Road
Building 6 / Offices Nos. 6-214 to 6-220
Dubai
Tel: +971-4-341 84 44
Fax: +971-4-341 88 52
E-Mail: info@miele.ae, Internet: www.miele.ae